



ISO 9001
ISO 14001



COMMON S.A.
ul. Aleksandrowska 67/93
91-205 Łódź
tel.: +48 42 253 66 00
tel.kom.: +48 601 255 580
fax: +48 42 253 66 99
e-mail: common@common.pl



CMK-03 GAS VOLUME CONVERTER

OPERATING INSTRUCTION

Edition: CMK3 / 102U

Firmware version: 2.2.39-39-2.7.8

Lodz, June 2016

Technical specification and construction may change due to improvement. This publication serves as general information only, and all specifications are subject to confirmation by COMMON S.A.

CONTENTS

1. INTRODUCTION	5
2. SAFETY AND OPERATION	5
2.1 Transportation	5
2.2 Storage	5
2.3 Periodical inspections	5
2.4 Warranty repairs	6
2.5 List of components and additional accessories	6
3. CONSTRUCTION	9
4. TECHNICAL DATA , CONDITIONS OF USAGE, MEASUREMENT INPUTS	10
4.1 Product code and version of execution	10
4.2 Technical data	12
4.3 Intrinsically safe parameters	17
5. ASSEMBLY AND INSTALLATION	19
5.1 Connections and outputs	20
5.1.1 TUCHEL port	20
5.1.2 Internal clamps	21
5.2 Cables of the intrinsically safe circuits	22
5.2.1 Requirements of cables	22
5.2.2 Parameters and cable types	22
5.3 Protective grounding	26
5.4 Connecting the temperature sensor	27
5.4.1 Connecting the thermometer to the volume converter	27
5.4.2 Connecting the thermometer to the piping	28
5.5 Connection the pressure sensor P1 and P2	29
5.6 Connection the external pressure CPC-03 converter	30
5.6.1 Mechanical installation of the CPC-03	30
5.6.2 Electrical connection of the CPC-03	30
5.7 Connecting the LF input to the gas meter	31
5.8 Mechanical installation of the CMK-03 — appendix 1	32
5.9 Battery	32
5.9.1 Main battery	32
5.9.2 Battery of LCD backlight	33
5.10 Conditions of safety usage	34
6. GAS VOLUME CORRECTION	34
6.1 Principles of operation	34
6.2 Algorithms	36
6.3 Bio-Gas configuration	37
7. ENERGY CONVERSION	38
8. METROLOGICAL MARKS, PROTECTION SEALS, NAME PLATES	39
8.1 Metrological marks – Seal 1 and Mark IV	39
8.2 Manufacturer protection seals – Seal 2	39
8.3 User protective seals – Seal 3	40
8.4 Marking of name plate	40
8.5 Seals placement inside the housing	41

8.6	Identification of software	44
9.	MID ALARMS	44
9.1	Principle of operation and list of alarms	44
9.2	Signalling, authorization and alarm acknowledgement	46
9.3	Principle of operation in the Vbe emergency conditions	46
10.	MID INTERFERENCES (CONFIGURATION CHANGES)	47
10.1	Principle of operation and list of parameters	47
10.2	Signalling, authentication and alarms acknowledgment	48
11.	LOCAL SERVICE	48
11.1	LCD menu structure	48
11.1.1	Menu Measure	52
11.1.2	Menu Archive	54
11.1.3	Menu Clock	58
11.1.4	Menu Name plate	58
11.2	Menu Settings	58
11.2.1	Configuration after installation	58
11.2.2	Parameters settings – general information	59
11.2.3	Log in	60
11.2.4	Settings of COM Ports parameters	61
11.2.5	Registration	63
11.2.6	Gas meter	63
11.2.7	Measure	64
11.2.8	Limits and “gas guard” function	66
11.2.9	Gas	67
11.2.10	Simulation	68
11.2.11	Inputs (IN)	69
11.2.12	Outputs (OUT)	70
11.2.13	Control of odorizing unit, OUT1 output proportional to Vbs	71
11.2.14	LCD	72
11.2.15	Users	72
11.2.16	Clock	73
12.	SETTINGS OF EXTENDED FUNCTIONALITIES	74
12.1	Summary alarms	74
12.2	Control of error of gas meter HF/LF constant	74
12.3	Operating below Qmin of the gas meter – in range QmSTOP <--> QmMIN	75
12.4	LCD power supply	75
12.5	Reserve1 configuration in GAZ-MODEM	75
12.6	Activity time of OPTO-GAZ port	76
13.	REMOTE CONTROL OF CMK-03, USERS, AUTHORIZATION	76
13.1	CCTool configurator	76
13.1.1	Connection by using COGUSB-03	77
13.1.2	Users and authorization	78
14.	DATA REGISTRATION, READING AND CONFIRGURATION IN TELEMETRIC SYSTEMS	79
14.1	Registered data	79
14.1.1	Data registered with registration period and and daily registered data	80





14.1.2	Events	82
14.2	Reading and configuration in the telemetric systems	83
15.	ENVIRONMENTAL PROTECTION	84
15.1	Packaging waste	84
15.2	Disposal of used batteries and devices after life-time	84
16.	HISTORY OF THE DOCUMENTATION CHANGES	85
17.	NOTES	86

1. INTRODUCTION

The CMK-03 Gas Volume Converter is a Type 1 converter (according to EN12405-1 + A2:2010) which fully meets the requirements of the MID Directive.

2. SAFETY AND OPERATION

The following warning marks are used in this manual:

	ATEX Directive requirements (intrinsic safety)
	installation and usage
	MID Directive requirements
	Packaging Regulations requirements (used accumulators and devices after their life time).
	recyclable packages

The installation and connection of the CMK-03 requires to follow according to recommendations of this operating instruction. The device should be used according with the regulation and rules of the explosion hazard safety.

The CMK-03 can be installed and operate in explosion hazard zone 1 or 2. The device can cooperate with the intrinsically safe circuits on security level "ia" or "ib". The subgroup conformity of the potentially gas mixture has to be maintained with the subgroup of device circuits (IIA or IIB) and temperature T4 class.



The CMK-03 can be connect to the intrinsically safe circuits of other devices, only accordingly to the safety rules of usage which are contained in the certificates and manufacturer instructions of this devices. The conformity of the intrinsically safe parameters has to be maintained for connected devices.



2.1 Transportation

The transportation should be carried out in the original packaging, which secures the device against the mechanical damage and assure a proper level of protection.

2.2 Storage

The elements of the CMK-03 should be storage in the original package in room with temperature from -20°C till +60°C and humidity which does not exceeding 80%, without vapour and chemically active compounds.

2.3 Periodic inspections

The CMK-03 is dedicated to installation and operation in the explosion hazard zones. To be sure that device and the installation system allows for safety usage, it is necessary to implement a regular periodical inspections or assure a continuous supervision by the qualified personnel. The proper services should be carried out in every necessary case.

The detailed guidelines regarding to the control frequency and control level can be found in the standard EN 60079-14:2008.

The devices with "X" sign in the certificate number have a special condition of usage, which are precisely described in the certificate documentation.

2.4 Warranty repairs

The manufacturer or a recommended authorized workshops should perform warranty repairs of the CMK-03. The method of usage after warranty repairs and post-warranty repairs, should be consistent with the regulations of the country where the device is installed.



The CMK-03 should be disassembled from the operating point in case of doubt regarding the correctness of instrument indications. The device should be pass to the appropriate laboratory for checking and verification. The checking may be carried out by means of control instruments without damage or removing the manufacturer's protection seals.

WARNING !

The removing or damage of manufacturer protection seal means the loss of guarantee and loss of intrinsically safe characteristic.





2.5 List of components and additional accessories



List of components:

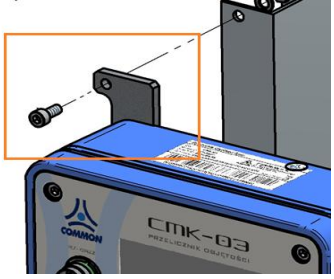

- CMK-03 Gas Volume Converter operating instruction
- guarantee card
- initial verification certificate (if there is present a mark of the initial verification)
- gasket of pressure connection M12 thread (type O-ring, dimensions 9,3x2,4mm)
- transporting cover of the pressure converter (plug P1, P2)
- cable glands plugs in dimension 6mm and 8mm
- sealed, protective covers for the PT1000, LF and HF clamps

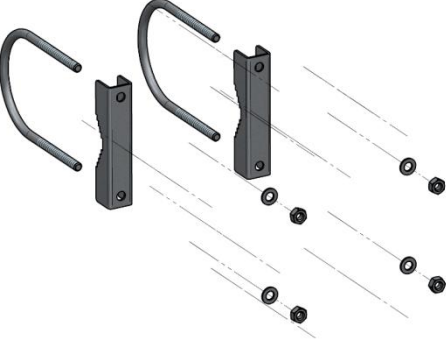
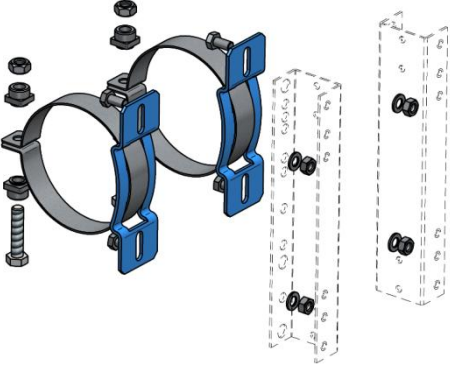
Table 2.1 Additional Accessories

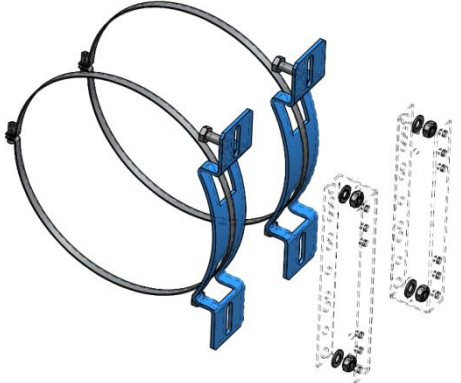
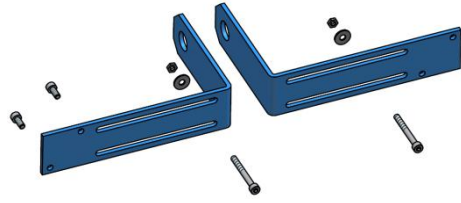
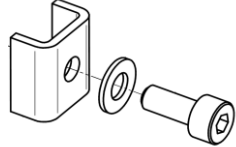
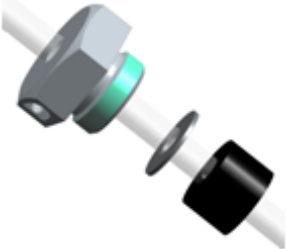
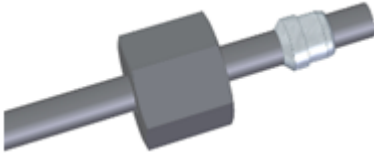
NR	additional accessories, set name:	example drawing										
1	cable sleeves for finishing the wires assembled on clamps: <ul style="list-style-type: none"> ▪ size 0,25mm²/ 8-10mm - 100 pcs. ▪ size 0,34mm²/ 8-10mm - 100 pcs. ▪ size 0,5mm²/ 8-10mm - 100 pcs. ▪ size 0,75mm²/ 8-10mm - 100 pcs. 											
2	<table border="1"> <thead> <tr> <th colspan="2">Assembly set through the holes in the housing</th> </tr> <tr> <th>Part name</th> <th>Quantity</th> </tr> </thead> <tbody> <tr> <td>bolt (cylinder type) M5x45</td> <td>4</td> </tr> <tr> <td>washer M5</td> <td>4</td> </tr> <tr> <td>nut M5</td> <td>4</td> </tr> </tbody> </table> see part 5.8.1	Assembly set through the holes in the housing		Part name	Quantity	bolt (cylinder type) M5x45	4	washer M5	4	nut M5	4	
Assembly set through the holes in the housing												
Part name	Quantity											
bolt (cylinder type) M5x45	4											
washer M5	4											
nut M5	4											

3	<table border="1"> <thead> <tr> <th colspan="2">Assembly set: O-Type, flat handles</th> </tr> <tr> <th>Part name</th> <th>Quantity</th> </tr> </thead> <tbody> <tr> <td>O-Type, flat handle</td> <td>4</td> </tr> <tr> <td>bolt (cylinder type) M5x40</td> <td>4</td> </tr> <tr> <td>bolt (cylinder type) M5x12</td> <td>4</td> </tr> <tr> <td>washer M5</td> <td>4</td> </tr> <tr> <td>nut M5</td> <td>4</td> </tr> </tbody> </table> <p>see part 5.8.2</p>	Assembly set: O-Type, flat handles		Part name	Quantity	O-Type, flat handle	4	bolt (cylinder type) M5x40	4	bolt (cylinder type) M5x12	4	washer M5	4	nut M5	4																														
Assembly set: O-Type, flat handles																																													
Part name	Quantity																																												
O-Type, flat handle	4																																												
bolt (cylinder type) M5x40	4																																												
bolt (cylinder type) M5x12	4																																												
washer M5	4																																												
nut M5	4																																												
4	<table border="1"> <thead> <tr> <th colspan="2">Assembly set: L-Type, flat handles, the replacement of the CMK-02</th> </tr> <tr> <th>Part name</th> <th>Quantity</th> </tr> </thead> <tbody> <tr> <td>L-Type, flat handle</td> <td>4</td> </tr> <tr> <td>bolt (cylinder type) M5x40</td> <td>4</td> </tr> <tr> <td>bolt (cylinder type) M5x12</td> <td>4</td> </tr> <tr> <td>washer M5</td> <td>4</td> </tr> <tr> <td>nut M5</td> <td>4</td> </tr> </tbody> </table> <p>see part 5.8.3</p>	Assembly set: L-Type, flat handles, the replacement of the CMK-02		Part name	Quantity	L-Type, flat handle	4	bolt (cylinder type) M5x40	4	bolt (cylinder type) M5x12	4	washer M5	4	nut M5	4																														
Assembly set: L-Type, flat handles, the replacement of the CMK-02																																													
Part name	Quantity																																												
L-Type, flat handle	4																																												
bolt (cylinder type) M5x40	4																																												
bolt (cylinder type) M5x12	4																																												
washer M5	4																																												
nut M5	4																																												
5	<table border="1"> <thead> <tr> <th colspan="2">Assembly set with the universal hangers</th> </tr> <tr> <th>Part name</th> <th>Quantity</th> </tr> </thead> <tbody> <tr> <td>left hanger universal set</td> <td>1</td> </tr> <tr> <td>right hanger universal set</td> <td>1</td> </tr> <tr> <td>universal strip of pipe holder</td> <td>2</td> </tr> <tr> <td>bolt M8x16</td> <td>4</td> </tr> <tr> <td>washer M8</td> <td>4</td> </tr> <tr> <td>nut M8</td> <td>4</td> </tr> </tbody> </table> <p>see part 5.8.4</p>	Assembly set with the universal hangers		Part name	Quantity	left hanger universal set	1	right hanger universal set	1	universal strip of pipe holder	2	bolt M8x16	4	washer M8	4	nut M8	4																												
Assembly set with the universal hangers																																													
Part name	Quantity																																												
left hanger universal set	1																																												
right hanger universal set	1																																												
universal strip of pipe holder	2																																												
bolt M8x16	4																																												
washer M8	4																																												
nut M8	4																																												
6	<table border="1"> <thead> <tr> <th rowspan="2">Part name</th> <th colspan="2">Quantity</th> </tr> <tr> <th>DN50</th> <th>DN80</th> </tr> </thead> <tbody> <tr> <td>pipe holder M8 x 61 (2")</td> <td>2</td> <td>-</td> </tr> <tr> <td>pipe holder M8 x 89 (3")</td> <td>-</td> <td>2</td> </tr> <tr> <td>connector of pipe holder ŁC8.61</td> <td>2</td> <td>-</td> </tr> <tr> <td>connector of pipe holder ŁC10.89</td> <td>-</td> <td>2</td> </tr> <tr> <td>washer M8</td> <td>4</td> <td>4</td> </tr> <tr> <td>nut M8</td> <td>4</td> <td>4</td> </tr> </tbody> </table> <p>see part 5.8.5</p>	Part name	Quantity		DN50	DN80	pipe holder M8 x 61 (2")	2	-	pipe holder M8 x 89 (3")	-	2	connector of pipe holder ŁC8.61	2	-	connector of pipe holder ŁC10.89	-	2	washer M8	4	4	nut M8	4	4																					
Part name	Quantity																																												
	DN50	DN80																																											
pipe holder M8 x 61 (2")	2	-																																											
pipe holder M8 x 89 (3")	-	2																																											
connector of pipe holder ŁC8.61	2	-																																											
connector of pipe holder ŁC10.89	-	2																																											
washer M8	4	4																																											
nut M8	4	4																																											
7	<table border="1"> <thead> <tr> <th rowspan="2">Part name</th> <th colspan="3">Quantity</th> </tr> <tr> <th>DN100</th> <th>DN150</th> <th>DN200</th> </tr> </thead> <tbody> <tr> <td>clamping ring with bolt DN100</td> <td>2</td> <td>-</td> <td>-</td> </tr> <tr> <td>clamping ring with bolt DN150</td> <td>-</td> <td>2</td> <td>-</td> </tr> <tr> <td>clamping ring with bolt DN200</td> <td>-</td> <td>-</td> <td>2</td> </tr> <tr> <td>base of band clip DN100</td> <td>2</td> <td>-</td> <td>-</td> </tr> <tr> <td>base of band clip DN150-200</td> <td>-</td> <td>2</td> <td>-</td> </tr> <tr> <td>base of band clip DN150-200</td> <td>-</td> <td>-</td> <td>2</td> </tr> <tr> <td>bolt M8x16</td> <td>4</td> <td>4</td> <td>4</td> </tr> <tr> <td>washer M8</td> <td>4</td> <td>4</td> <td>4</td> </tr> <tr> <td>nut M8</td> <td>4</td> <td>4</td> <td>4</td> </tr> </tbody> </table> <p>see part 5.8.5</p>	Part name	Quantity			DN100	DN150	DN200	clamping ring with bolt DN100	2	-	-	clamping ring with bolt DN150	-	2	-	clamping ring with bolt DN200	-	-	2	base of band clip DN100	2	-	-	base of band clip DN150-200	-	2	-	base of band clip DN150-200	-	-	2	bolt M8x16	4	4	4	washer M8	4	4	4	nut M8	4	4	4	
Part name	Quantity																																												
	DN100	DN150	DN200																																										
clamping ring with bolt DN100	2	-	-																																										
clamping ring with bolt DN150	-	2	-																																										
clamping ring with bolt DN200	-	-	2																																										
base of band clip DN100	2	-	-																																										
base of band clip DN150-200	-	2	-																																										
base of band clip DN150-200	-	-	2																																										
bolt M8x16	4	4	4																																										
washer M8	4	4	4																																										
nut M8	4	4	4																																										

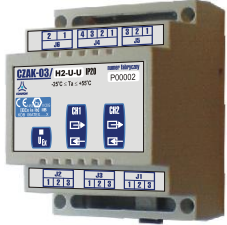
8	<table border="1"> <thead> <tr> <th colspan="3">Assembly set with the band clips</th> </tr> <tr> <th rowspan="2">Part name</th> <th colspan="2">Quantity</th> </tr> <tr> <th>DN250</th> <th>DN300</th> </tr> </thead> <tbody> <tr> <td>band clip with lock</td> <td>2</td> <td>2</td> </tr> <tr> <td>base of band clip DN250-300</td> <td>2</td> <td>2</td> </tr> <tr> <td>bolt M8x16</td> <td>4</td> <td>4</td> </tr> <tr> <td>washer M8</td> <td>4</td> <td>4</td> </tr> <tr> <td>nut M8</td> <td>4</td> <td>4</td> </tr> </tbody> </table> <p>see part 5.8.5</p>	Assembly set with the band clips			Part name	Quantity		DN250	DN300	band clip with lock	2	2	base of band clip DN250-300	2	2	bolt M8x16	4	4	washer M8	4	4	nut M8	4	4	
Assembly set with the band clips																									
Part name	Quantity																								
	DN250	DN300																							
band clip with lock	2	2																							
base of band clip DN250-300	2	2																							
bolt M8x16	4	4																							
washer M8	4	4																							
nut M8	4	4																							
9	<table border="1"> <thead> <tr> <th colspan="2">Assembly set with bars mounted into collar</th> </tr> <tr> <th>Part name</th> <th>Quantity</th> </tr> </thead> <tbody> <tr> <td>assembly bars into collar</td> <td>2</td> </tr> <tr> <td>bolt (cylinder) M5x45</td> <td>2</td> </tr> <tr> <td>washer M5</td> <td>2</td> </tr> <tr> <td>nut M5</td> <td>2</td> </tr> <tr> <td>bolt (cylinder type) M5x12 (assembly of the CKMT valve)</td> <td>2</td> </tr> </tbody> </table> <p>see part 5.8.6</p>	Assembly set with bars mounted into collar		Part name	Quantity	assembly bars into collar	2	bolt (cylinder) M5x45	2	washer M5	2	nut M5	2	bolt (cylinder type) M5x12 (assembly of the CKMT valve)	2										
Assembly set with bars mounted into collar																									
Part name	Quantity																								
assembly bars into collar	2																								
bolt (cylinder) M5x45	2																								
washer M5	2																								
nut M5	2																								
bolt (cylinder type) M5x12 (assembly of the CKMT valve)	2																								
10	<p>grounding clamp elements: plate + spring washer + bolt (available in the CMK-03 set; spare part)</p>																								
11	<p>The assembly set of thermometer in the thermowell; the set is adapted to sealing by the cord – bolt nut, washer, seal see part 5.4.2</p>																								
12	<p>The tightening nut M12x1,5 of the pressure measurement pipe, sleeve, pulse pipe. The length and material (cooper or acid-resistant stainless steel) have to be indicate by the order.</p>																								
13	<p>The CKMT three way manometrical valve. The detailed information are contained in the service manual and the technical documentation of this device — available on the web site: www.common.pl</p>																								
14	<p>The CPC-03 Pressure Converter The selected information about converter are described in the Table 4.5 — “The measuring converters of the CMK-03”. The detailed information are contained in the service manual and the technical documentation of this device — available on the web site: www.common.pl</p>																								

15	<p>The CZAK-03 Communication and Signal Barrier</p> <p>The detailed information are contained in the manual instruction and the technical documentation of this device — available on the web site www.common.pl</p>	
16	<p>Optical communications interface COGUSB-03.</p> <p>Detailed information contains manual instruction and technical documentation of the device available on web site: www.common.pl</p>	
17	<p>The female, TUCHEL contact, C091D Type (to the COM1 transmission port)</p>	

3. CONSTRUCTION

The CMK-03 Gas Volume Converter is a measuring and accounting instrument which fulfills the requirements of MID Directive. The device is dedicated to operate on the measuring and reducing & measuring gas stations. It can be used with any of the gas meter (turbine, rotor or ultrasonic) which provides information about measured volume in the pulses.

The CMK-03 is a battery power supplied instrument with possibility to operate on the external power supply. The installed batteries provide continuous and service less data registration for a minimum 6 years.

The CMK-03 is a volume converter of the gas Type 1. This is complete measurement system, equipped in the pressure converters, the temperature converters, the input of pulses/volume of the meter and the algorithms for converting the measured volume of gas to the basic conditions.

The construction of the CMK-03 has an additional inputs and outputs, which allow for a usage to the technological purpose and to the control and measurement processes. The inputs and outputs are listed below:

- control inputs LFB and LFC
- Encoder input,
- HF transmitter input in NAMUR standard
- double ExtCPC input for external technological CPC-03 converters,
- double-state, signal outputs OUT
- double-state, signal inputs IN
- input IN in NAMUR standard

The data reading and also the CMK-03 power supply are carried out by using three independent communication ports in the **RS-GAZ2** standard: **COM1 ("Tuchel/OPTO-gas")**, and **COM2** and **COM3**.

The housing is made from the aluminum what assure durability, resistance and a high level of waterproofness — IP66/67. The opening of the cover is a hinge with the limiter what allows for easy access to the wire clamps and the battery unit.

The **LCD** display with keyboard, the port **OPTO-GAZ** port and the **RS-GAZ2 (TUCHEL)** port are located in the device cover. There are maximum two pressure converters **P1** and **P2** which are built in the housing base. The P1 Converter occurs also as an external version which is constant connected via a cable with the CMK-03. The metal cable glands are located in the base of the housing. They are adapted for the shielded cables. This solution raises the resistance of the device electrical circuits against the electromagnetic interference.

The CMK-03 is equipped in the LCD display with graphical-text menu. The LCD is readable in the entire temperature range. The display backlight is supported by the additional battery which is independent of the converter main battery.

The protection level of housing will be preserved if the conditions will be filled as listed below:

- appropriate diameters of the connection cables
- correct tightening of the cable gland,
- proper positioning of the gaskets and tightening of the housing cover



4. TECHNICAL DATA, USAGE CONDITIONS, MEASUREMENT INPUTS

4.1 Product code and version of the execution

Table 4.1 Code of product and versions

GAS VOLUME CORRECTOR CMK-03		date: 31.03.2015.							
PARAMETERS CODING AND VARIANTS OF EXECUTION									
CMK-03 /	CODE(1)	type and scope of the internal P1 pressure converter							
	CODE(A)	- absolute pressure converter from Table CODE(A)							
	CODE(2)	assembly (internal / external) and type of terminal (thread) for P1 converter							
	12	Internal module of CPC-03 converter, terminal (thread) M12							
	e12	External module of CPC-03 converter, terminal (thread) M12							
	eG1	External module of the CPC-03 converter, terminal (thread) G1/2 (special order)							
	...	other orders							
	CODE(3)	type and scope of the internal pressure converter P2							
	CODE(A)	absolute pressure converter	CODE(G)	overpressure converter					
	3A	50 - 300kPa	G10	0 - 10kPa					
	6A	90 - 600kPa	G17	0 - 17kPa					
	17A	250 - 1700kPa	1G	0 - 100kPa					
	40A	600 - 4000kPa	6G	0 - 600kPa					
	70A	1000 - 7000kPa	16G	400 - 1600kPa					
	-	without P2 converter	63G	1400 - 6300kPa					
CODE(4)	P2 converter terminal type (thread)								
12	terminal (thread) M12								
...	others on order								
CODE(5)	thermometer pipe length [dm] / cable length [dm]								
S	standard = thermometer pipe length xx=16 (160mm) - cable length yy = 25 (2,5m)								
xxyy	xx=05(45mm); 08(75mm); 10(95mm); 11(105mm); 12;13;14;16;18;20 22 25(245mm)								
xyyy	yy=12 (1,2m); 25 (2,5m); 40 (4,0m); 50 (5,0m); 60 (6,0m); 80 (8,0m); 99 (9,9m)								
CODE(6)	COM1 port terminal ("TUCHEL")								
C	Złącze portu COM1 - standard								
-	without COM1 port on the housing								
CODE(7)	device and firmware version								
S	standard (with Encoder and HF sensor)								
CODE(8)	type of the calculating algorithm / special type of gas								
M	according to MID certificate								
T	firmware without MID requirements (technological)								
CODE(9)	language version / country of destination								
PL	polish version								
EN	english version								
product code example:									
CMK-03 /	6A /	12 /	G10 /	12 /	1625 /	C /	S /	M /	PL
CMK-03 /	3A /	e12 /	- /	- /	0512 /	C /	- /	M /	PL

additional equipment e.g.:

external CPC-03:

- regarding to table of execution from Technical Documentation

CMK-03 assembly set:

- regarding to table of execution from Technical Documentation

3 way gauge:

- CKMT

thermometer assembly set in the thermowell

- ...

Table 4.2 The spare parts list

NR.	PART DESCRIPTION:	TYPE:	EXAMPLE DRAWING
1	Main battery	BAT-03 manufactured by COMMON S.A.	
2	LCD backlight battery	SL-760 Xtra manufactured by Tadiran	

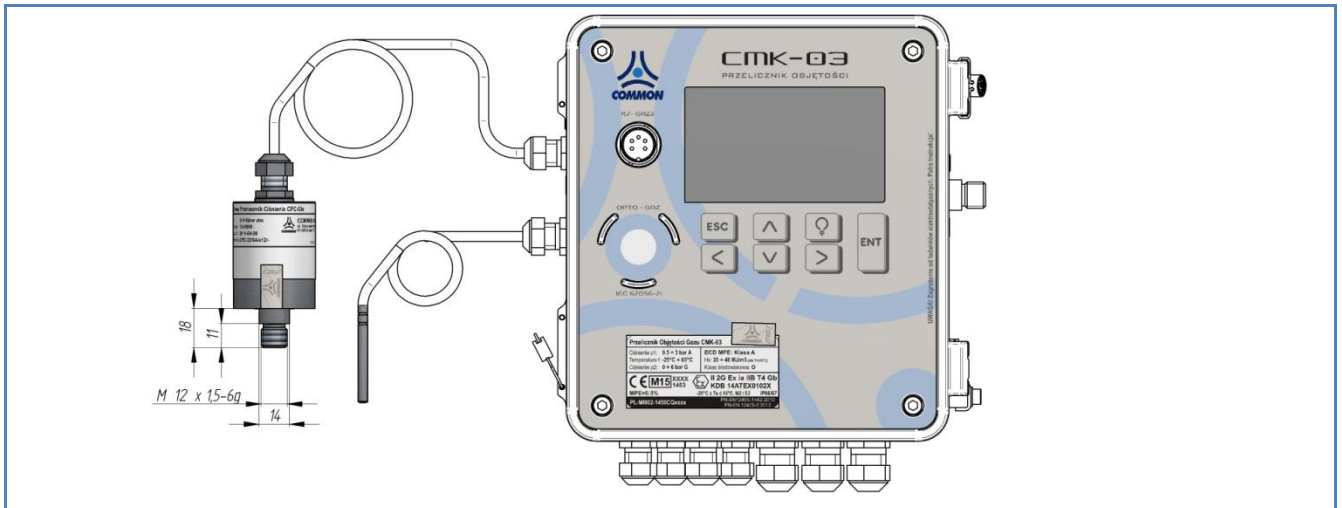

Table 4.3 The examples of the CMK-03 available variants

EXAMPLES OF THE CMK-03 VARIANTS
<p>CMK-03/x/12/-/0512/....</p>
<p>CMK-03/x/12/x/12/0512/....</p>
<p>CMK-03/x/e12/x/12/0512/....</p>



4.2 Technical data

Table 4.4 The technical parameters

MARKINGS	
meteorological markings and MID certificate number	 1450 PL-MI002-1450CQ0001
Explosion proof construction	 II 2G Ex ia IIB T4 Gb
markings and ATEX certificate number	 1453 KDB 14ATEX0102X
conformity with norms and directives	94/9/WE ATEX: PN-EN 60079-0:2013-03 + A11:2014-03 (EN 60079-0:2012/A11:2013 [IDT]) PN-EN 60079-11:2012 (EN 60079-11:2012 [IDT])
	2004/22/WE (MID): PN-EN 12405-1+A2:2010 (EN 12405-1:2005+A2:2010 [IDT])
	energy calculation: PN-EN 12405-2:2012 (EN 12405-2:2012 [IDT])
	2004/108/WE (EMC): PN-EN 12405-1+A2:2010 (EN 12405-1:2005+A2:2010 [IDT]) PN-EN 55016-2-3: 2010 + A1: 2010 (EN 55016-2-3: 2010 + A1: 2010) PN-EN 55011:2012 (EN 55011:2009, EN 55011:2009/A1:2010)
OPERATING CONDITION	
ambient temperature	(-25°C + +55 °C)
relative humidity	max 95% In temp. 55°C, possibility of condensation of water vapor
electromagnetic environmental conditions	class E2 (class of protection)
mechanical environmental conditions	class M2
environmental conditions	class O – for inside and outside room installation
HOUSING	
metal	aluminum cast – pressure method
the protection level of the housing	IP66/67
dimensions (total, without terminals)	height - 190 mm, width - 170mm, depth - 70 mm
front, elevation, keyboard, display	polycarbonate or polyester 185 x 165 mm 7 keys Graphic, backlight display 240x128
closing	cover with housings gasket on hinge. Closed with 4 cylinder bolts 4mm
grounding	clamp for ground connection stainless steel, max. cable cross-section 16mm ² , cylinder bolt key size 3mm
weight	2,4kg

THE HOUSING OF THE CPC-03e EXTERNAL CONVERTER (variant with external p1, look at the Table 4.3)	
metal	acid-resistant stainless steel
protection level of housing	IP66/67
dimension (total)	total length 90 mm, diameter 38mm
connection with CMK-03 volume converter	factory mounted permanent connection. Cable length – 2,5m.
POWER SUPPLY	
main internal	2 sets of battery type: BAT-03 manufactured by COMMON S.A. (execution KOD(7)=S). life time of battery set – minimum 5 years in typical operating conditions (detailed information – part 5.9.2)
internal for LCD backlight	SL-760 Xtra Or TL-5903 manufactured by Tadiran
external	CZAK-03 power supply unit with NAMUR which output assures EX circuit separation / manufactured by COMMON S.A. other power supply unit with input parameters ($U_n = 5\div 7,14V$; $I_n=65mA$) by maintaining intrinsically safe parameters. Intrinsically safe parameters – Table 4.13
resistance of the electric insulation	500V AC
WARNING! The input circuit on the COM2 and COM3 ports contain the protective, overvoltage safety elements which secure the electrical terminals on the level approx. 90 V towards housing.	



Table 4.5 The measuring converters

P1 PRESSURE CONVERTER (parameter under metrological control)	
converter type	built-in sensor or sensor on the cable ended with thread (code 2 / Table 4.1)
terminal type	M12 x1,5 (others variants on the special order)
GAS PRESSURE MEASUREMENT RANGES FOR P1 CONVERTER (code 1 / Table 4.1)	
absolute pressure converters	
3A	0,5 ÷ 3 bar abs
6A	0,9 ÷ 6 bar abs
17A	2,5 ÷ 17 bar abs
40A	6 ÷ 40 bar abs
70A	10 ÷ 70 bar abs
P2 PRESSURE CONVERTER	
converter type	built-in sensor ended with the M12 X 1.5 thread (code 4 / Table 4.1)
terminal type	M12 X 1.5 (others variants on the special order)
GAS PRESSURE MEASUREMENT RANGES FOR P2 CONVERTER (code 3 / Table 4.1)	
absolute pressure converters	
3A	0,5 ÷ 3 bar abs
6A	0,9 ÷ 6 bar abs
17A	2,5 ÷ 17 bar abs
40A	6 ÷ 40 bar abs
70A	10 ÷ 70 bar abs
gauge pressure converters	
G10	0 ÷ 10 kPa G
G17	0 ÷ 17 kPa G
1G	0 ÷ 100 kPa G
6G	0 ÷ 600 kPa G
16G	400 ÷ 1600 kPa G
63G	1400 ÷ 6300 kPa G
t — TEMPERATURE CONVERTER (parameter under metrological control)	
converter type	built-in converter with attached PT1000 resistance thermometer class 2/3A (± 0,1° C) CTA4 Type manufactured by COMMON S.A. The thermometer is permanent connected with the volume converter via a cable. The thermometer is marked with a serial number. The serial number is readable on the LCD (code 5 / Table 4.1) The connection clamps of the thermometer are secured with the sealed cover by the user or manufacturer.
measuring range of gas temperature	-25°C ÷ +65°C
thermometer cable length	to 10 m (code 5 / Table 4.1)

outer diameter of the thermowell	6mm
CPC-03 DIGITAL CONVERTERS (EXTERNAL, SWITCHABLE) FOR THE P3, P4 PRESSURE MEASUREMENT	
converter type	The external CPC-03 digital pressure converters manufactured by COMMON S.A. (ordered separately)
terminal type	M20 X 1.5 thread (others variants on the special order according to the CPC-03 instruction)
level of housing protection	IP 66/67
operating temperature	-25 °C to +55 °C
relative humidity	max 95% in temp 55°C
supply	external from the ExtCPC clamps
GAS PRESSURE MEASUREMENT RANGES OF THE P3, P4 CONVERTERS	
absolute pressure converter	gauge pressure converters
3A 0,5 ÷ 3 bar abs	G10 0 ÷ 10 kPa G
6A 0,9 ÷ 6 bar abs	G17 0 ÷ 17 kPa G
17A 2,5 ÷ 17 bar abs	1G 0 ÷ 100 kPa G
40A 6 ÷ 40 bar abs	6G 0 ÷ 600 kPa G
70A 10 ÷ 70 bar abs	16G 400 ÷ 1600 kPa G
	63G 1400 ÷ 6300 kPa G

Table 4.6 Inputs and Outputs

LF PULSE INPUTS (parameter under metrological control)	
DESCRIPTION	LF pulse input from the index head of gas meter
parameters	maximum frequency 2 Hz , minimum pulse durations – 200ms , compatibility with: <ul style="list-style-type: none"> ▪ reed relay transmitter, ▪ electronic, potential-free contact (open-collector, open-drain), ▪ Wiegand type transmitter resistance of the closed state < 50kΩ, resistance of the open state > 500 kΩ
pulse value	0,01 ; 0,1 ; 1; 10 m3/imp
LFb, LFc, HF PULSE INPUTS	
LFb	double-state input. The control circuit (LFbreak)
LFc	double-state input. The programmable function: counting, directional
HF	high frequency pulses input of the HF sensor. The NAMUR interface. Fmax=5kHz. WARNING! the external power supply +8,2V is required to the COM3 port.
INx SIGNAL INPUTS	
IN1, IN2, IN3, IN4, IN5, IN6.	double-state inputs compatibility with <ul style="list-style-type: none"> ▪ reed relay transmitter, ▪ electronic, potential-free contact (open-collector), ▪ Wiegand type transmitter. IN5 and IN6 are software set as a switchable to the operation as a double-state input or NAMUR standard. WARNING! The operating mode in the NAMUR standard requires the external power supply +8,2V to the COM3 port
OUTx SIGNAL OUTPUTS	
OUT1, OUT2, OUT3, OUT4.	signaling double-state outputs – open collector . (Ui=10V, Ii=0,3A) programmable, released by the control function or by the alarm. Possible operating modes: OUT2 – steering output of the odorizing unit OUT2 – frequency output proportional to the selected parameter OUT3 – representation of the LF input signal OUT3 – representation of the HF input signal
ENC INPUTS	
The input compatible with the CWSL-N Type Encoder digital encoder manufactured by COMMON S.A.	

ExtCPC INPUTS

There is a dual input dedicated to the connection for maximum two of the external CPC-03 digital pressure converters. The input assures the power supply for **P3** and **P4** converters and digital data transmission to the **CMK-03** (also in the battery supply working mode).

Table 4.7 Measuring counters

COUNTERS (under metrological control)		
Vm [m ³] - volume counter in measuring conditions	capacity and total precision	11.2 significant place
	display format on the LCD	11.2 significant place
Vb [m ³] - volume counter in base conditions	capacity and total precision	11.8 significant place
	display format on LCD	11.3 significant place
Vbe [m ³] - volume counter in emergency conditions	capacity and total precision	11.8 significant place
	display format on LCD	11.3 significant place
OTHER COUNTERS		
E [kWh] – energy counter	capacity and total precision	11.8 significant place
Ee [kWh] – energy counter in emergency conditions	LCD displaying format	11.3 significant place
Vbs [m ³]= Vb + Vbe summary counter of the base volume	capacity and total precision	11.8 significant place
	LCD displaying format	11.3 significant place
Es [m ³]= E + Ee summary energy count	capacity and total precision	11.8 significant place
	LCD displaying format	11.3 significant place



Table 4.8 The register of the alarms and MID interferences

MID ALARMS REGISTER (metrological significant)	
Size of the MID alarms base	▪ minimum 256 records (max. 288)
Protection against data removing	▪ acknowledgment with user authorization
Rotary register	▪ the oldest data are deleting and overwriting with the latest, only when the alarms are acknowledged and completed
MID INTERFERENCES REGISTER (metrological significant)	
Size of the MID interferences register base	▪ minimum 128 records (max.144)
Rotary register	▪ the oldest data are deleting and overwriting with the latest

Table 4.9 Data transmission

DATA TRANSMISSION	
communication ports: COM1 COM2 COM3	RS-GAZ2 interface – four wire communication port with the supply line V+, GND and RS-485 standard transmission lines in the intrinsically safe execution up to 115200 bits/s . WARNING! COM1 port is a “male” TUCHEL socket on housing.
Port OPTO-GAZ	The optical transmission interface accordant with the EN 62056-21 standard. Baud rate up to 115200 bits/s by using COGUSB-04 interface manufactured by COMMON S.A . WARNING! COM1 and OPTO-GAZ ports are shared. The active OPTO-GAZ port blocks transmission on the COM1 port.
WARNING ! The input circuit on the COM2 and COM3 ports contain the protective, overvoltage safety elements which secure the electrical terminals on level approx. 90 V towards the housing.	

Table 4.10 Compressibility coefficient – the calculating methods

CALCULATING METHODS FOR COMPRESSIBILITY COEFFICIENT			
	APPLICATION RANGE (extended)		UNIT
SGERG-88 calculating in function of PTZ according to PN-EN ISO 12213-3:2011 (EN ISO 12213-3:2009 [IDT])	p1	0,5 ÷ 3; 0,9 ÷ 6; 2,5 ÷ 17	bar abs
	t	-23,15 ÷ +65	°C
	p1	6 ÷ 40; 10 ÷ 70	bar abs
	t	-10 ÷ +65	°C
	Hs	20 ÷ 48	% mole
	d	0,55 ÷ 0,9	% mole
	CO2	0 ÷ 30 (carbon dioxide)	% mole
	H2	0 ÷ 10 (hydrogen)	% mole
	N2	0 ÷ 50 (nitrogen)	% mole
	CH4	50 ÷ 100 (methane)	% mole
	C2H6	0 ÷ 20 (ethane)	% mole
	C3H8	0 ÷ 5 (propane)	% mole
	C4H10	0 ÷ 1,5 (butane)	% mole
	C5H12	0 ÷ 0,5 (pentane)	% mole
	C6H14	0 ÷ 0,1 (hexane)	% mole
	C7H16	0 ÷ 0,05 (heptane)	% mole
C8+	0 ÷ 0,05 (octane and higher hydrocarbons)	% mole	
CO	0 ÷ 3 (carbon monoxide)	% mole	
He	0 ÷ 0,5 (helium)	% mole	
H2O	0 ÷ 0,015 (water)	% mole	
AGA8-92DC calculating in function of PTZ according to PN EN ISO 12213-2:2010 (EN ISO 12213-2:2009 [IDT])	p1	0,5 ÷ 3; 0,9 ÷ 6; 2,5 ÷ 17; 6 ÷ 40; 10 ÷ 70	bar abs
	t	-23,15 ÷ +65	°C
	Hs	20 ÷ 48	MJ*m-3
	d	0,55 ÷ 0,9	-
	CO2	0 ÷ 30 (carbon dioxide)	% mole
	H2	0 ÷ 10 (hydrogen)	% mole
	N2	0 ÷ 50 (nitrogen)	% mole
	CH4	50 ÷ 100 (methane)	% mole
	C2H6	0 ÷ 20 (ethane)	% mole
	C3H8	0 ÷ 5 (propane)	% mole
	C4H10	0 ÷ 1,5 (butane)	% mole
	C5H12	0 ÷ 0,5 (pentane)	% mole
	C6H14	0 ÷ 0,1 (hexane)	% mole
	C7H16	0 ÷ 0,05 (heptane)	% mole
C8+	0 ÷ 0,05 (octane and higher hydrocarbons)	% mole	
CO	0 ÷ 3 (carbon dioxide)	% mole	
He	0 ÷ 0,5 (helium)	% mole	
H2O	0 ÷ 0,015 (water)	% mole	
K1=const calculating in function of PT	K = 1		-
	p1 < 1,5		bar abs
	K ≠ 1		-
	p1 < 1,5		bar abs
	WARNING! For K1=const.≠1 it is necessary to configure ranges of pressure and temperature (dlp1K1, glp1K1, dltK1, gltK1) that in this ranges change of p1 and t not cause error greater than 0,25% of K1		
REFERENCE CONDITIONS			
Basic pressure to the volume calculation		pb = 1.01325 bar	
Basic temperature to the volume calculation		Tb = 273.15 K (0°C) Tb = 288.15 K (15°C) Tb = 293.15 K (20°C)	
Reference temperature of the combustion processes (out of the legal metrological control)		T1 = 273.15 K (0°C) T1 = 288.15 K (15°C)	

T1 = 293.15 K (20°C)
T1 = 298.15 K (25°C)

Table 4.11 The list of errors

VALUE UNDER METROLOGICAL CONTROL					
	REFERENCE CONDITIONS $T_{amb} = (+20 \pm 3) ^\circ\text{C}$		OPERATING CONDITIONS $T_{amb} = (-25 \div +55) ^\circ\text{C}$		
INDICATION	TYPICAL ERROR	LIMITING ERROR MPE (acc. PN-EN 12405-1+A2:2010)	TYPICAL ERROR	LIMITING ERROR MPE (wg. PN-EN 12405-1+A2:2010)	
Vb	< 0,2 %	0,5 %	< 0,4 %	1 %	
ENERGY					
	REFERENCE CONDITIONS $T_{amb} = (+20 \pm 3) ^\circ\text{C}$		OPERATING CONDITIONS $T_{amb} = (-25 \div +55) ^\circ\text{C}$		
INDICATION	TYPICAL ERROR	LIMITING ERROR MPE (acc. PN-EN 12405-2:2012)	TYPICAL ERROR	LIMITING ERROR MPE (acc. PN-EN 12405-2:2012)	
E	< 0,2 %	Klasa A	< 0,4 %	Klasa A	
OTHER INDICATIONS					
	REFERENCE CONDITIONS $T_{amb} = (+20 \pm 3) ^\circ\text{C}$		OPERATING CONDITIONS $T_{amb} = (-25 \div +55) ^\circ\text{C}$		
INDICATION	TYPICAL ERROR	LIMITING ERROR	TYPICAL ERROR	LIMITING ERROR	
p1 (abs)	0,13 %	0,2 % measured value (all ranges)	TBD	0,35 % measured value (all ranges)	
p2 (abs)	0,13 %	0,2 % measured value (all ranges)	TBD	0,35 % measured value (all ranges)	
p2 (G)	G10	TBD	±0,04 kPa	TBD	±0,08 kPa
	G17	TBD	±0,05 kPa	TBD	±0,1 kPa
	1G	TBD	±0,15 kPa	TBD	±0,3 kPa
	6G	TBD	±0,2 kPa dla p < 100 kPa ±0,2 % dla p > 100 kPa	TBD	±0,4 kPa dla p < 100 kPa ±0,4 % dla p > 100 kPa
	16G	TBD	±0,2 % measured value	TBD	±0,4 % measured value
	63G	TBD	±0,2 % measured value	TBD	±0,4 % measured value
T	± 0,04 %	± 0,08 %	± 0,08 %	± 0,12 %	
RTC clock	± 3ppm	± 5ppm @ Tamb -15÷+55°C	± 5ppm (<0,5s/24h)	± 10ppm (<1s/24h)	

The error values, which are presented in percent (%) are referred to the measured value. The temperature error is referred to the Kelvin temperature scale.

4.3 Intrinsically safe parameters

WARNING! Hazard of the electrostatic charges.

The front cover of the CMK-03 (elevation, keyboard, display window) is a large surface made of plastic where the electrostatic charges can be accumulated. To avoid electrify effect and danger of discharge this surface can not be rubbed with dry materials!



The intrinsically safe parameters are determinate during the analysis of the device structure. Their values are specified related to the worst-case of operating conditions or failure situation. The parameters are limited to the safe levels of the indicated explosive mixture. They should not be understood as a technical reference parame-

ters. The conformity conditions of the intrinsically safe parameters for the connected devices are presented in the Table 4.12.

Table 4.12 The conformity conditions of the intrinsically safe parameters

CONFORMITY CONDITIONS OF THE INTRINSICALLY SAFE PARAMETERS				
DEVICE A		CONDITION	DEVICE B	
output voltage	Uo	≤	Ui	input voltage
output current	Io	≤	Ii	input current
power output	Po	≤	Pi	power input
maximum external capacity	Co	$Co \geq Ci + Ck$	Ci	Internal capacity
maximum external inductance	Lo	$Lo \geq Li + Lk$	Li	Internal inductance

The dispersed parameters of the cables should be taken as:

- worst case design parameters declared by the cable manufacturer
- the parameters measured according to the EN 60079-14 standard or 200pF/m and 1μH/m or 30μH/Ω where the connection include 2 or 3 wires (shielded or not).

Table 4.13 Intrinsically safe parameters

PORT/ CONNECTOR	CLAMP	PARAMETERS
COM1	V+, GND, A, B number of pins: 4, 5, 2, 1	<u>clamps „1” – „2” („B” – „A”)</u> Ui=7,14V, Pi=1,2W, Li~0, Ci~0 Uo=5,88V, Io=21mA, Po=30mW, Lo=50mH, Co=100μF <u>clamps „1” – „GND” , „2” – „GND” („B” – „GND” , „A” – „GND”)</u> Ui=7,14V, Uo=5,88V, Io=83mA, Po=121mW, Lo=25mH, Co=100μF <u>clamps „4” – „5” („V+” – „GND”)</u> Ui=7,14V, Pi=1,2W, Ii=0,5A, Li~0, Ci~0 Uo=7,14V, Po=0,76W, Io=0,43A, Lo=1mH, Co=48μF
	V+, GND, A, B	<u>clamps („B” – „A”)</u> Ui=7,14V, Pi=1,2W, Li~0, Ci~0 Uo=5,88V, Io=21mA, Po=30mW, Lo=50mH, Co=100μF <u>clamps „B” – „GND” , „A” – „GND”</u> Ui=7,14V, Uo=5,88V, Io=83mA, Po=121mW, Lo=25mH, Co=100μF <u>clamps „V+” – „GND”</u> Ui=7,14V, Pi=1,2W, Ii=0,5A, Li~0, Ci=73nF Uo=7,14V, Po=0,76W, Io=0,43A, Lo=1mH, Co=48μF
COM3	V+, GND, A, B	<u>clamps („B” – „A”)</u> Ui=7,14V, Pi=1,2W, Li~0, Ci~0 Uo=5,88V, Io=21mA, Po=30mW, Lo=50mH, Co=100μF <u>clamps „B” – „GND” , „A” – „GND”</u> Ui=7,14V, Uo=5,88V, Io=83mA, Po=121mW, Lo=25mH, Co=100μF <u>clamps „V+” – „GND”</u> Ui=7,14V, Pi=1,2W, Ii=0,5A, Li~0, Ci=73nF Uo=7,14V, Po=0,76W, Io=0,43A, Lo=1mH, Co=48μF
	+8V, GND:	<u>clamps „+8V” – „GND”</u> Ui=12,6V, Ii=0,3A, Pi=1,1W, Li~0, Ci~0
INx IN1 IN2 IN3 IN4	IN1+ , IN1- IN2+ , IN2- IN3+ , IN3- IN4+ , IN4-	<u>clamps „IN1+” – „IN1-” ... „IN4+” – „IN4-”</u> Ui=10V, Ci~0, Li~0, Uo=10V, Io=2,5mA, Po= 6mW, Lo=10mH, Co=20μF
IN5 IN6	IN5+ , IN5- IN6+ , IN6-	<u>clamps „IN5+” – „IN5-” , „IN6+” ... „IN6-”</u> Ui=12,6V, Li~0, Ci~0 Uo=12,6V, Io=18mA, Po=57mW, Lo=20mH, Co=7μF

OUTx	OUT1-1 , OUT1-2 (bipolar) OUT2-1 , OUT2-2 (bipolar) OUT3-1 , OUT3-2 (bipolar) OUT4-1 , OUT4-2 (bipolar)	<u>clamps „OUT1-1”-„OUT1-2”, „OUT2-1”-„OUT2-2”, „OUT3-1”-„OUT3-2”, „OUT4-1”-„OUT4-2”</u> Uo=5,88V , Io=6mA , Po=9mW, Lo=50mH, Co=100µF, Li~0, Ci=0,6uF Ui=10V, li=0,3A, Pi=1,1W
ExtCPC	V+, GND, A, B	<u>clamps „A” – „B”</u> Uo=5,88V, Io=62mA, Po=45mW, Lo=50mH, Co=100µF, Li~0, Ci~0 <u>clamps „A” – „GND”, „B” – „GND”</u> Uo=5,88V, Io=124mA, Po=91mW, Lo=10mH, Co=100µF, Li~0, Ci~0 <u>clamps „V+” – „GND”</u> Uo=5,88V , Io=0,74A , Po=0,8W (summary power output of all clamps on ExtCPC), Li~0, Ci~0, Lo=500µH, Co=100µF
HF	HF+, HF-	Uo=12,6V, Io=17mA, Po=54mW, Lo=50mH, Co=7µF
ENC	ENC+, ENC-	Uo=10,5V, Io=15mA, Po=38mW, Lo=50mH, Co=16µF
LF	LF+ , LF-	<u>clamps „LF+” – „LF-”</u> Uo=10V, Io=15mA, Po=25mW, Lo=50mH, Co=16µF Ui=10V, li=30mA, Pi=64mW
LFb LFC	LFb+ , LFb- LFC+ , LFC-	<u>clamps „LFb+” – „LFb-”, „LFC+” – „LFC-”</u> Uo=10V, Io=2mA, Po=4mW, Lo=20mH, Co=16µF Ui=10V, li=30mA, Pi=64mW
PT1000	clamps and cables colors: PT-I+ , PT-U+ , PT-U- , PT-I- lub PT-I+ , PT-U+ , PT-U- , PT-I-	<u>clamps PT-I+, PT-I-, PT-U+, PT-U-</u> (between any of clamps) Uo=5,88V, Io=54mA, Po=79mW Lo=50mH Co=63µF

5 Assembly and installation

It is absolutely necessary to follow the recommendations of this operating instruction by the installation and connection of the CMK-03. The device should be used according to the regulation and rules concerning anti-explosion safety.

The CMK-03 can be installed and operate in explosion hazard zone 1 or 2. The device can cooperate with the intrinsically safe circuits on the security level “ia” or “ib”. The subgroup conformity of the potentially gas mixture has to be maintained with the subgroup of device circuits (IIA or IIB) and temperature T4 class.



The CMK-03 can be connect to the intrinsically safe circuits of other devices, only according to the safety rules of usage which are contained in the certificates and manufacturer instructions of this devices. The conformity of the intrinsically safe parameters has to be maintained for the connected devices.



5.1 Connectors and outputs

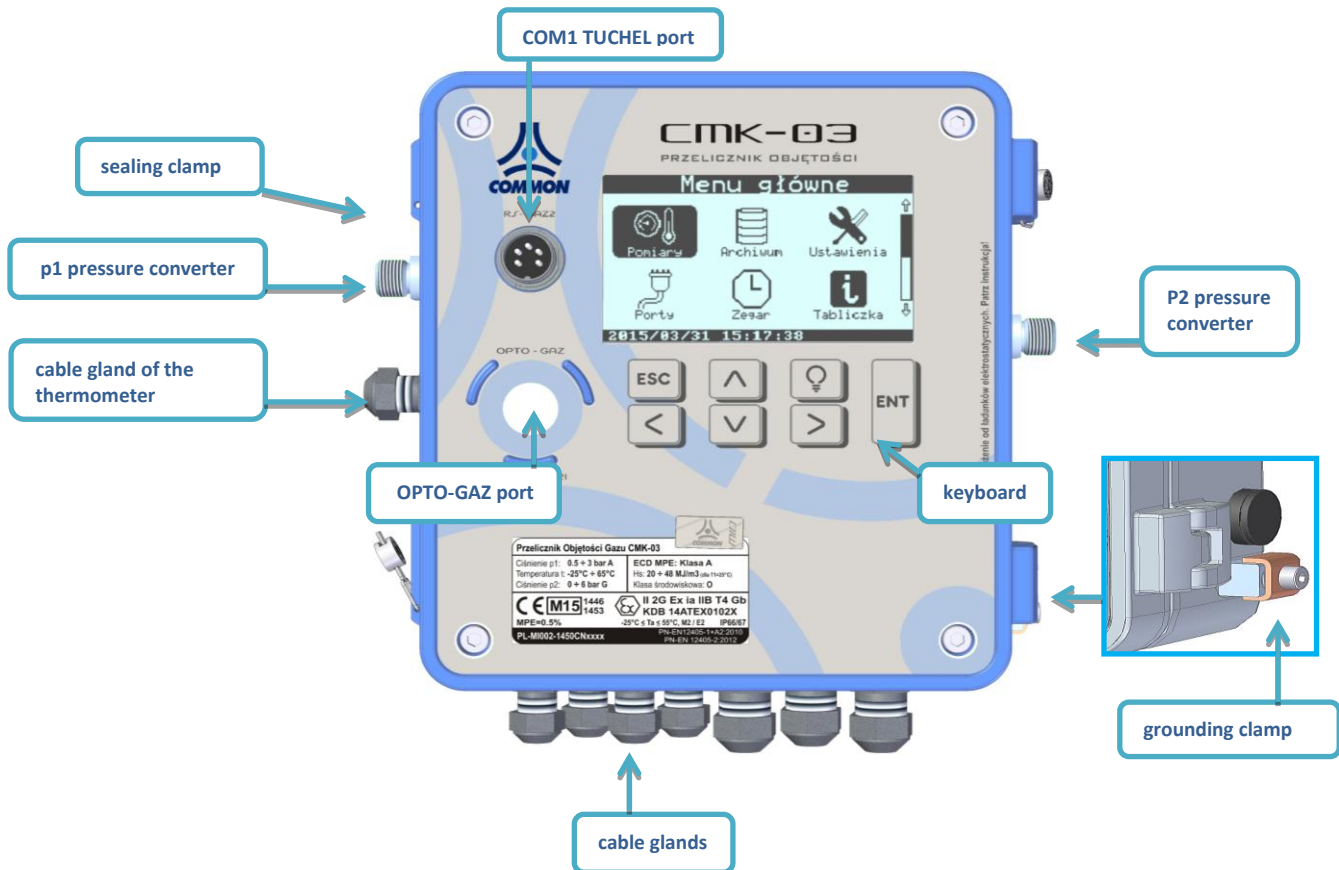

Figure 5.1 The sockets positions

5.1.1 TUCHEL port

The 5 pins TUCHEL connector is placed on the housing. The port enables to connect the power supply and to transmit the data by using COM1 port. The pins designation is described in Figure 5.2.

It is recommended to use CZAK-03 barrier to connect the power supply to the CMK-03. The CZAK-03 is manufactured by COMMON S.A. (see Table 2.1 Additional Accessories).

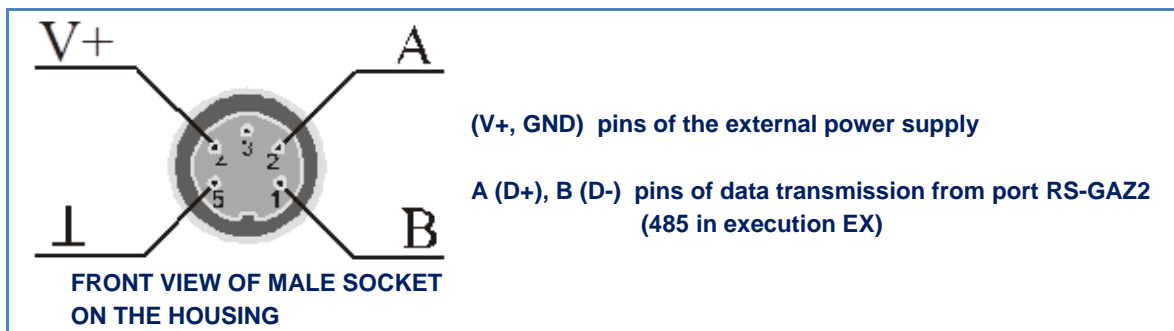

Figure 5.2 The TUCHEL connector — "male" type socket, 5 pins, C091D type

5.1.2 Internal clamps

The clamps are dedicated to the connection of the signals and external devices.

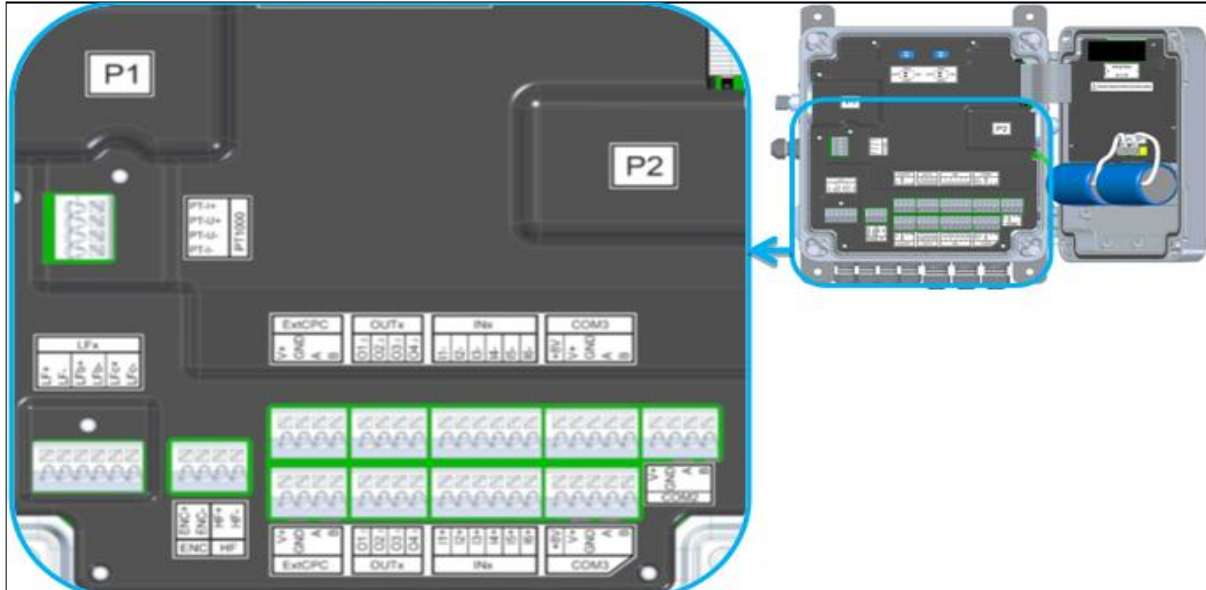

Figure 5.3 connectors positions – diagram

WARNING!

It is obligatory to connect correctly the intrinsically safe circuits of the device. It is not allowed to connect to the CMK-03 clamps any external devices with undefined purpose.

For example: the connection between the output of external power supply (V+,GDN,A,B) with the ExtCPC output of the CPC-03 external converter may occurs permanent device damage and loss of intrinsically safe parameters.



Table 5.1 Description of the CMK-03 connectors

CABLE CONNECTORS		
LFx	LF+, LF-	input of the LF pulse from gas meter index head
	LFB+, LFB-	input of the control circuit from gas meter index head (LFbreak)
	LFC+ LFC-	input of the LFc pulse from gas meter index head (from 2nd pulse transmitter, control type)
PT1000	PT-I+	thermometer connection clamps (details – part 5.6)
	PT-U+	
	PT-U-	
	PT-I-	
ExtCPC	V+	power supply outputs for an external CPC-03 pressure converter (details – part 5.6)
	GDN	
	A B	serial transmission port, to the external CPC-03 pressure converter (details – part 5.6)
OUTx	OUT1₁, OUT1₂	control outputs OC (open collector) bipolar outputs – polarity insignificant WARNING! pair connected wires (OUT1₁, OUT1₂) (OUT2₁, OUT2₂) (OUT3₁, OUT3₂) (OUT4₁, OUT4₂)
	OUT2₁, OUT2₂	
	OUT3₁, OUT3₂	
	OUT4₁, OUT4₂	
INx	IN(1+4)+ IN(1+4)-	signaling double-state inputs (contact type)
	IN(5+6)+ IN(5+6)-	signaling double-state inputs (contact type) or inputs in the NAMUR standard (configurable)
COM2, COM3	+8V	supply voltage input for the NAMUR sensors (only COM3 port)
	V+	external supply input for the RS-GA22 interface
	GND	

	A	serial transmission signals of the RS-GA22 port
	B	

* clamps symbols A and B are also marked accordingly as D+ and D–

5.2 Cables of the intrinsically safe circuits

5.2.1 Requirements of the cables

The CMK-03 is constructed as an intrinsically safe device. The all terminal and ports are intrinsically safe circuits.



The multi-wires cables of the intrinsically safe circuit and the method of their installation and connection in the areas with the explosion hazard must be accordant to the requirements of the EN 60079-14 standard. There is acceptable to use the cables A Type or B Type in the accordance with the paragraph 12.2.2 of the mentioned standard.

The general requirements for the multi-wire cable which are dedicated to the CMK-03 intrinsically safe circuits:

- permanent installation, protected against the mechanical damages
- operating temperature range of the cables should be proper in relation to the temperature on the installation point
- minimum, radial thickness of the insulation for every wire of the cable should be not less than 0.2 mm
- dielectric strength of the “wire — ground” insulation — minimum **500 V AC (rms)**,
- dielectric strength of the “wire — wire” insulation — minimum **1000V AC (rms)**,
- wires diameter in the multi-wire cable — minimum 0,1 mm,
- the ends of the multi-wires cable need to be protected to avoid the separation of the internal twisted pairs wires. In this case the soldering process is not enough and the ends should be protected by using the sleeves.
- **unused wire** in the areas with the **explosion hazard should be connected to the ground or isolated by the connection to the terminal strips**. The **isolation tape is not allowed**.

The intrinsically safe cables should be marked. In case of marking with the color it should be used light blue color.

If the wiring is outside of the explosion hazard area and it is need to connect intrinsically safe cables together with the normal cables (intrinsically safety no required), the cables should be separated accordingly to the EN 60079-14 standard.

5.2.2 Parameters and types of the connection cables

The M12 and M16 cable grommets enter the connection cables to the CMK-03 housing. The cable are connected to the proper clamps (Figure 5.3).

The all cable glands are in EMC execution and are adjusted to connection of the cable shields in their entering place.



In the CMK-03 there are two types of the cable glands: **M12** and **M16** — a ranges of the cable glands diameter are listed in the Table below.

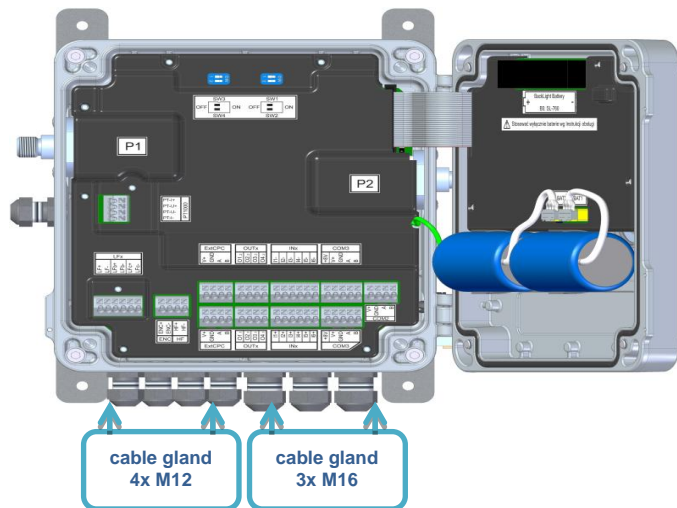

DIAMETER OF THE CABLE GLANDS	
M12	4,5 ÷ 6mm
M16	6,5 ÷ 8mm

Figure.5.4 The cables entering to the housing, the dimensions of cable glands M12, M16

The unused cable glands should be covered by using a cylindrical elements which are made from the hard or elastic material with the proper dimension. The gland nuts should be tighten up.

The cross sections of the cable wires is presented in the Table 5.2.

Table 5.2 The ranges of wire cross section of the cable wires

RANGES OF CABLES WIRE CROSS-SECTION	
one-wire cable	0,20 ÷ 1,5 mm ²
cord cable with pressed connector sleeve with a collar	0,14 ÷ 1,5 mm ²

The maximum lengths of cables for a individual circuits are presented in the Table 5.3. The values are defined regarding to:

- the voltage decrease of cable resistance
- the output of rated voltage from CZAK-03 power supply unit.

Table 5.3 Maximum cable length

CABLE MAXIMUM LENGTH			
cable type	cross-section	load	maximum length
LFx, ExtCPC	Dowolny z zakresu	-	<10m
COM1, COM2, COM3, OUTx, INx,	1,5mm ²	standard	750m
	1,5mm ²	full	125m
	1mm ²	standard	500m
	1mm ²	full	80m
	0,75mm ²	standard	370m
	0,75mm ²	full	60m
	0,5mm ²	standard	250m
	0,5mm ²	full	40m
	0,34mm ²	standard	170m
	0,34mm ²	full	28m
	0,25mm ²	standard	125m
	0,25mm ²	full	20m
COM1, COM2, COM3, OUTx, INx,	0,14mm ²	standard	70m
	0,14mm ²	full	10m

where:

- **standard load** means that CMK-03 is operating with active: LCD, LCD backlight, unit uC, measurement of T and P and active transmission on one of the COM ports
- **full load** means that CMK-03 is operating with the active options mentioned above and additionally with the activated read function from the Encoder and from the two external CPC-03 converters (connected to the extCPC port).

The inductance and the electrical capacity of the cables with defined length must be taken under consideration in the analysis of the conformity of the intrinsically safe parameters for connected devices.



The examples of the cable are presented in the Table 5.4.

Table 5.4 Types of the shielded cables

TYPES OF THE SHIELDED CABLES	
circuit type	cable type
LFx, ExtCPC, OUTx, INx, COM1	Use only shielded cables e.g. LIYCY
COM2, COM3	Shielded cables e.g. LIYCY or unshielded cables e.g. LIYY

There is important to use the cables which are dedicated to conditions on the installation point (the earth cables or the outdoor cables).

The cord cables (multi-wire) must be ended with the wire sleeves with an insulated collar. The sleeve should be pressed on the all length. The preparation method of the cables is presented in the Table 5.5.

Table 5.5 Method of the cable preparation

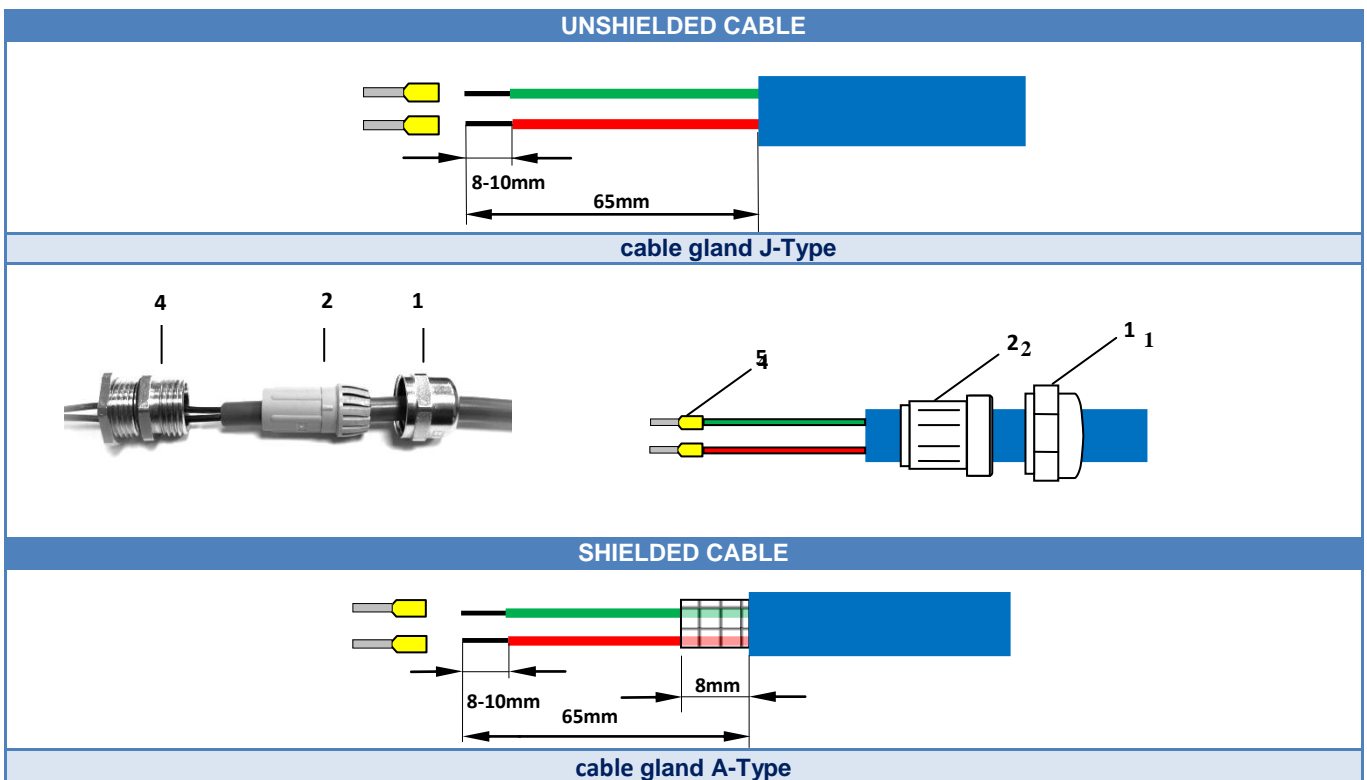

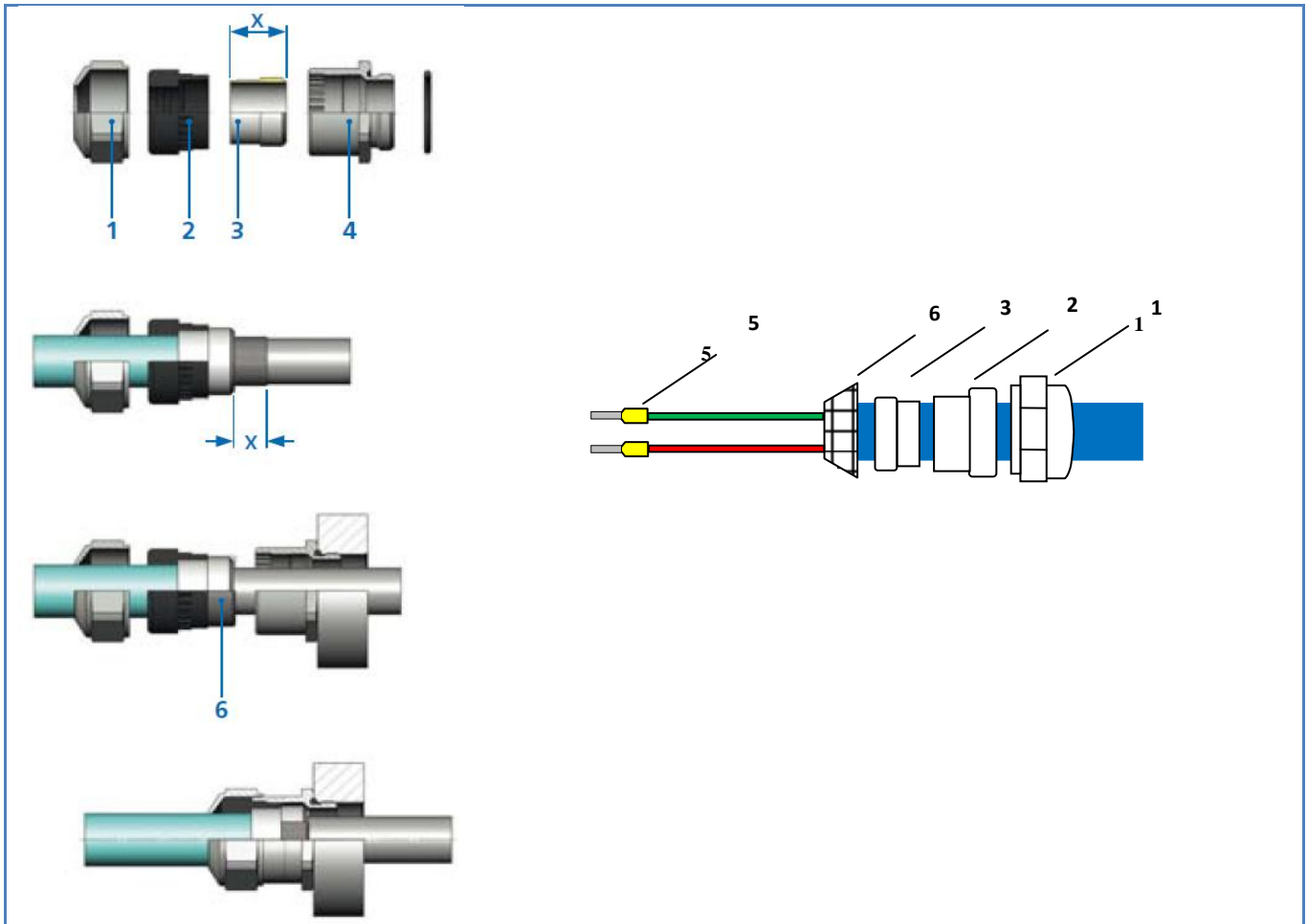

cable gland J-Type

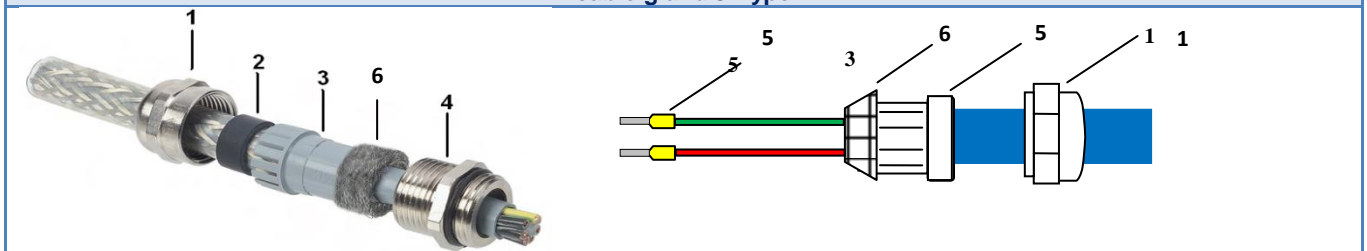

cable gland P-Type (yellow elastomer)

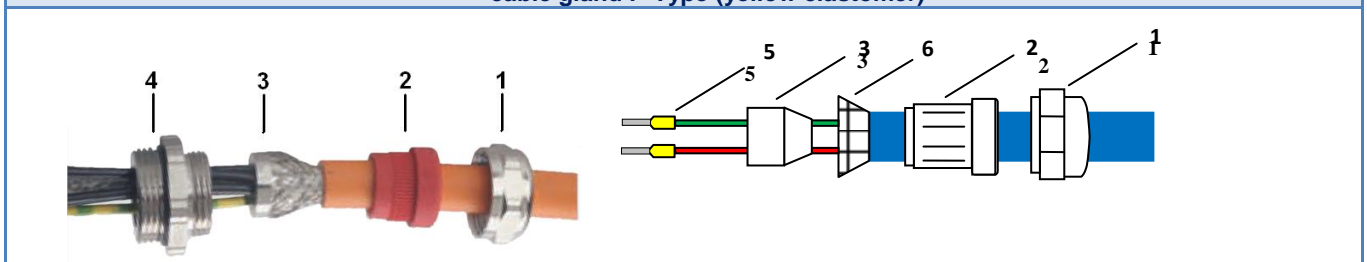
**LEGEND:**

1. gland nut
2. sealing elastomer
3. sealing element which presses the cable shield
4. gland inlet screwed into the CMK-03 housing
5. sleeve
6. cable shield

WARNING!

The cable shields should be connected to the CMK-03 housing only on the grounded side by using the cable glands. The shielded cables can not create loops, closing points with different potentials, where could be flow equalizing currents.



WARNING!

The housing 'IP' protection level will be preserved only if:

- will be used appropriate diameters of the connection cables or the covers
- cables grommets will be proper tightened,
- gasket will be in proper position
- housing cover will be tightened correctly



5.3 Protective grounding

WARNING! The CMK-03 housing must be grounded

The grounding methods of the CMK-03 housing:

1. Installation bolts in the housing corners

The metal handles (CMK-03 installation sets) should be tightened to the mounting holes of the housing and next the converter should be tighten by using them to grounded metal elements of the installation

2. Ground clamp connection

The CMK-03 effective ground connection can be assure by using the ground clamp, which is located on the side of housing. There can be connected a single wire or multi-wire cable with cross-section up to 4mm.

The clamp is tightened with a cylindrical bolt, key size 3mm.

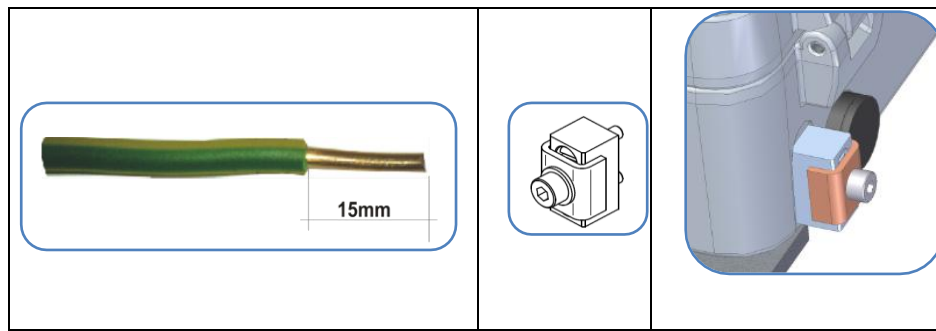

Figure 5.5 earth connection clamp

The additional grounding methods of the housing, which can not occur as only one earth connection are listed below:

1. pressure converter pipe (located on the housing) is mostly connected via a steel pulse pipe with the pressure measurement terminal of the gas meter or piping.
2. thermometers steel pipe is electrical connected via cable shield with device housing.
3. housing of the CPC-03 External Pressure Converter is connected via cable shield with device housing.

WARNING!

The equipotentiality of the housing grounding point must be assure with:

- the connection place of the pulse pipe to the gas meter or the gas line.
- the thermometer installation place
- the external CPC-03e converter installation place



5.4 Connecting the temperature sensor

The CMK-03 is equipped in the platinum temperature sensor (PT 1000 Class 2/3A) CTA4 Type, manufactured by COMMON S.A. The sensor allows for the measurement and registration of the gas temperature in range $-25^{\circ}\text{C} \div +65^{\circ}\text{C}$.

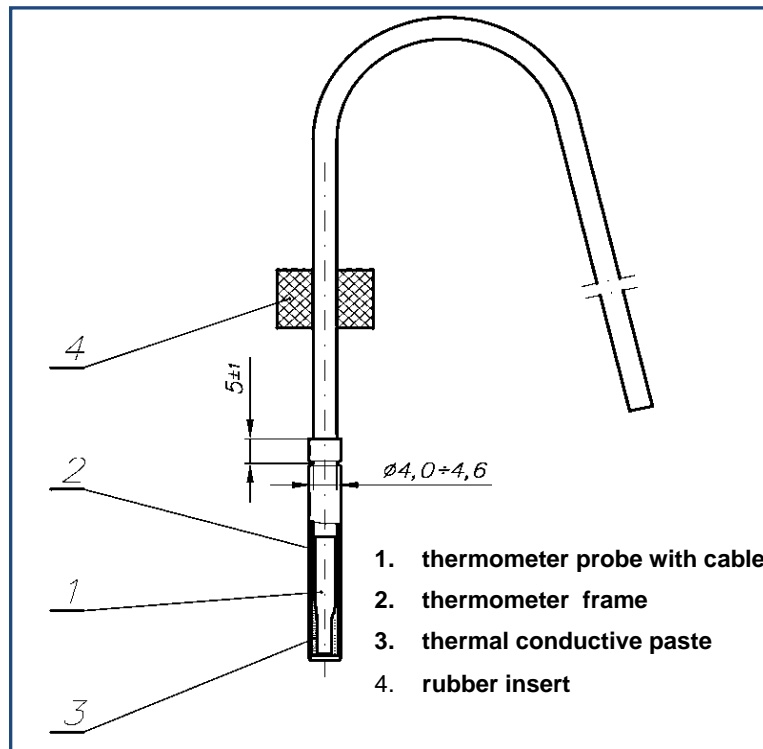

Figure 5.6 The CTA4 thermometer manufactured by COMMON S.A.

The length of the thermometer pipe and the cable are presented in the Table 5.6. The maximum length of the thermometer cable is 10 meters. The method of order is described in the Table 4.1 (code 5).

Table 5.6 Method of the cable preparation

PIPE AND CABLE LENGTH OF THERMOMETER			
thermometer pipe length		cable lengths	
<ul style="list-style-type: none"> 45 mm 75 mm 95 mm 105 mm 120 mm 130 mm 	<ul style="list-style-type: none"> 140 mm 160 mm-standard 180 mm 200 mm 220 mm 245 mm 	<ul style="list-style-type: none"> 1,2 m 2,5 m + standard 4,0 m 5,0 m 	<ul style="list-style-type: none"> 6,0 m 8,0 m 9,9 m

The thermometer pipe can have electrical contact with installation of the gas line, that why there is necessary to follow according to guidelines described in part 5.3.

5.4.1 Connecting the thermometer to the volume converter.

The thermometer cables are factory connected, to clamps of the port marked as PT 1000 inside the housing. The thermometer name plate is placed on the thermometers cable. The thermometer serial number is recorded in the CMK-03 memory on the production phase and it is displayed on the LCD screen. The thermometer is formal combined and identified with model of CMK-03.

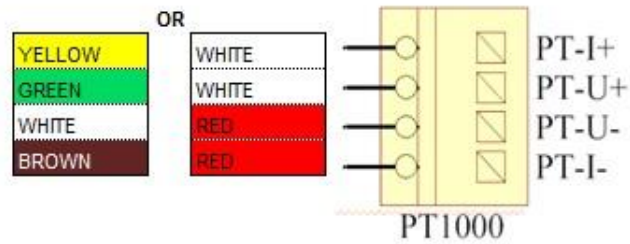

Figure 5.7 Cables connection of the CTA4 thermometer.

The terminal clamps are protected against the interference with the factory sealed cover.

The breakdown of the manufacturers seal from the PT1000 clamps cover, does not affect on the metrological features of instrument. It gives possibility to check periodically the correctness of working thermometer and correctness of the input data line. The clamps cover of the PT1000 must be properly placed and sealed with a users seal after every service activities. From this time the user is responsible for the correct connection of the thermometer.



5.4.2 Connecting the thermometer to the piping.

The thermometer is placed in the thermowell, which is located in the piping or gas meter. It is sealed with a rubber gasket and secured with a tightening nut (M12 thread) (see Table 2.1, Additional Accessories).

The tightening nut is adjusted to the sealing (there is a hole for a sealing cord). The example of thermometer installation in the piping is presented in the Figure 5.8.

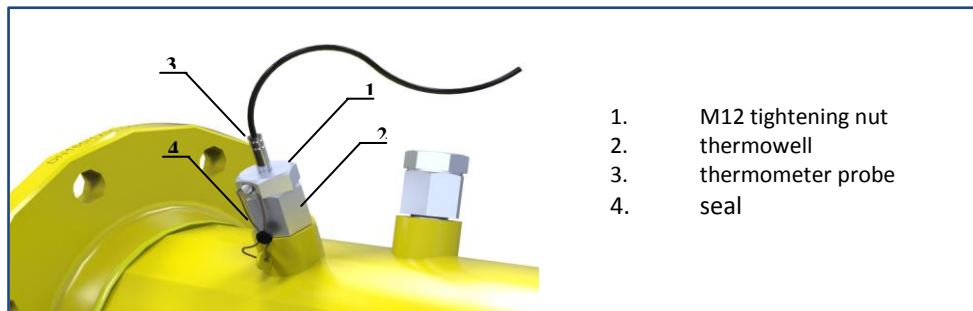

Figure 5.8 Thermometer assembly in piping

The Figure 5.9 presents the thermometer placement in the body of gas meter.

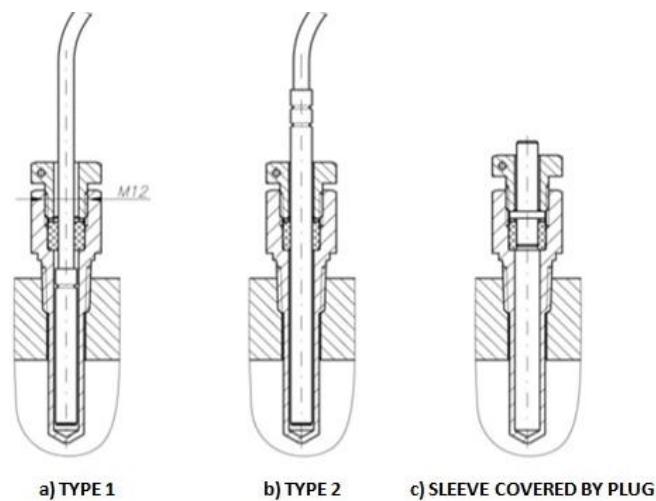

Figure 5.9 The PT1000 thermo probes assembled in the body of CGT-02 Turbine Gas Meter manufactured by COMMON S.A.

5.5 Connecting the P1 and P2 pressure sensors

The CMK-03 has maximum two built-in pressure converters (P1 and P2 in the Figure 5.10). The connection pipe of the converter has a thread M12x1,5 in the typical application. The available variants and the pressure ranges are listed in the Table 4.5.

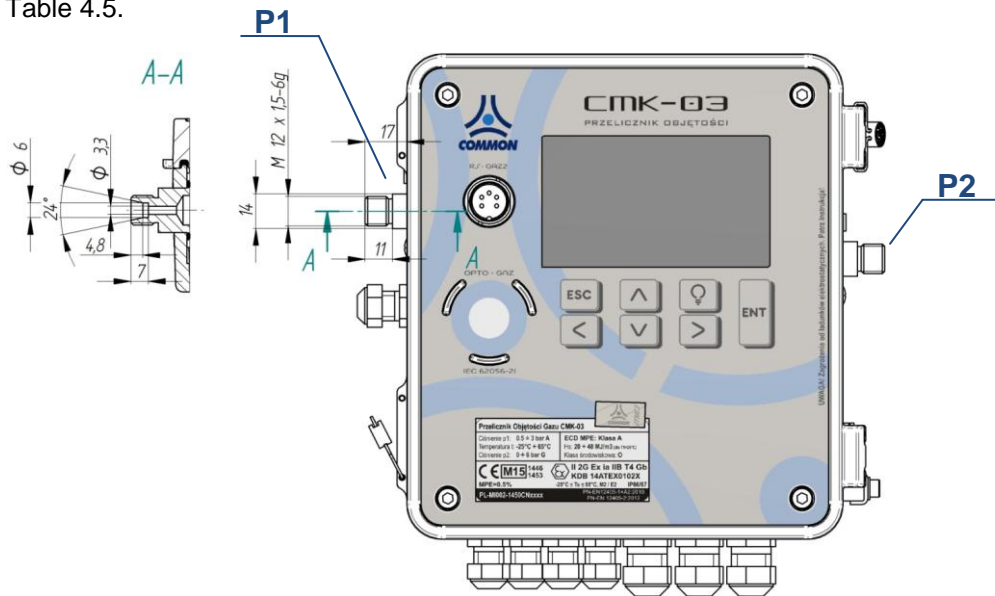

Figure 5.10 The construction of the M12x1,5 pressure connection pipe

The measuring pressure pipe, should be connected to the pressure sensor by using the pulse pipe. The connection method of the pulse pipe from the converter side is presented in the Figure 5.11 (M12x5 nut, the tightening ring, the pulse pipe — all items are available as an additional accessories — see Table 2.1).



Figure 5.11 The connection of the pressure measurement to the P1 pressure sensor

There is a **CKMT** three way between the point of pressure measurement and the measuring converter valve in the typical application of the piping (see **Table 2.1**). The CKMT three way valve is manufactured by COMMON S.A. This instrument allows for the inspections and checking of the sensors. The example of the installation for the pressure connection is presented in the Figure 5.12.

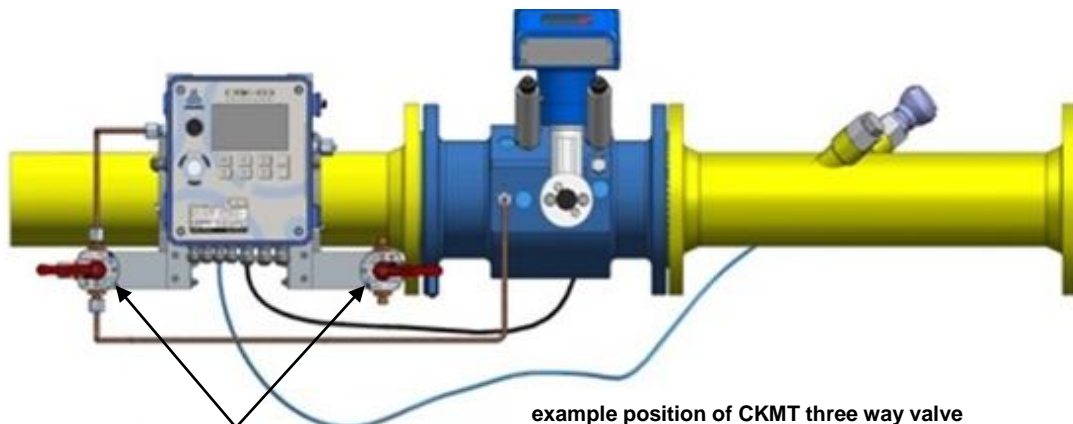

Figure 5.12 The example of pressure connection by using the CKMT valve manufactured by COMMON S.A.

WARNING!

The connection of the pressure sensors is an electrical contact between the housing and piping. Such connection can not be understood as the “grounding connection”. The grounding methods are described in the part 5.3.

5.6 Connecting the CPC-03 external pressure converter

The CMK-03 allows for a reading and registration of the pressure values from two CPC-03 external, digital converters manufactured by COMMON S.A. (Table 2.1. Additional Accessories). The technical data of the CPC-03 converter are available in the operating instruction.

5.6.1 Mechanical installation of the CPC-03

The **CPC-03** converter is dedicated to connect to the processing socket with a defined type. Typically there is a **M20x1,5** manometrical socket. The other types are available on the special order. The installation of CPC-03 requires the proper sealing.

The CPC-03 ground connection is achieved when the instrument is threaded to the grounded part of the piping, gas meter etc. If there is no possibility to assure connection with the ground in such way, the CPC-03 housing should be grounded by using a cable with the proper cross-section (**minimum 4mm²**), tightened to the marked ground clamp on the side of housing (the detailed information are contained in the CPC-03 operating instruction).

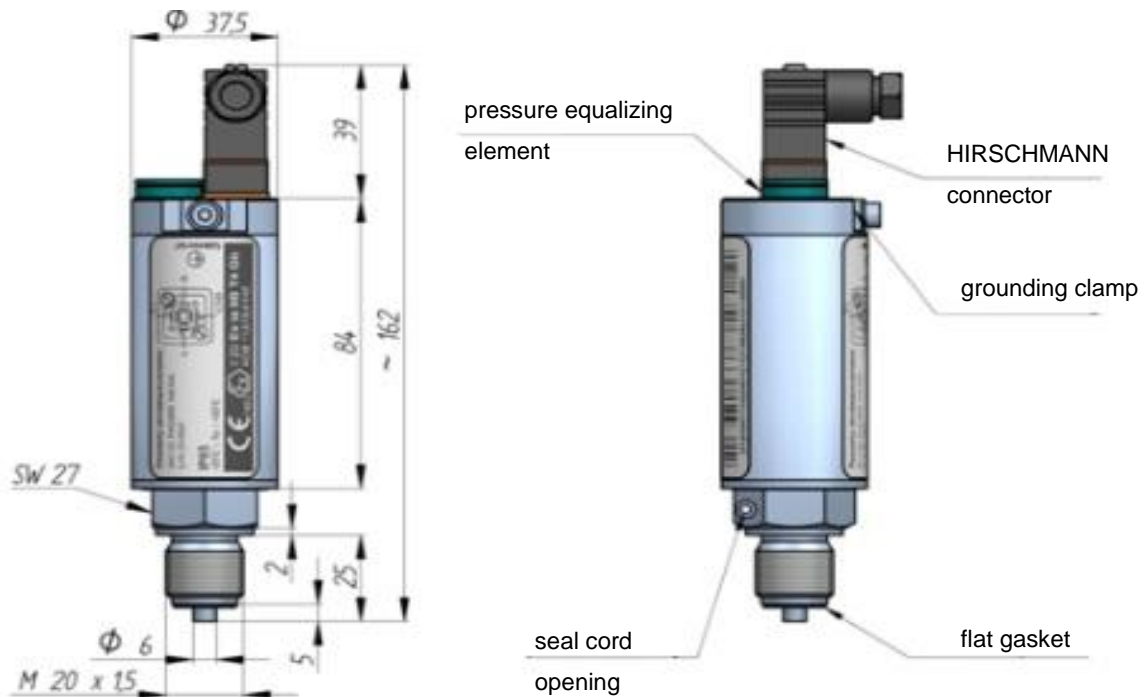

Figure 5.13 CPC-03 converter - mechanical installation

5.6.2 Electrical connection of the CPC-03

The power supply and data transmission are assured by using the ExtCPC clamps of the converter. **The converters are adjusted to operation in the areas of explosion hazard, according to the marking about explosion-proof construction.**

The CPC-03 can be installed and operate in explosion hazard zone 1 or 2. The subgroup conformity of the potentially gas mixture has to be maintained with the subgroup of device circuits (IIA or IIB) and temperature T4 class.



The connections between the converter port and converter clamps are presented in the Figure 5.14.

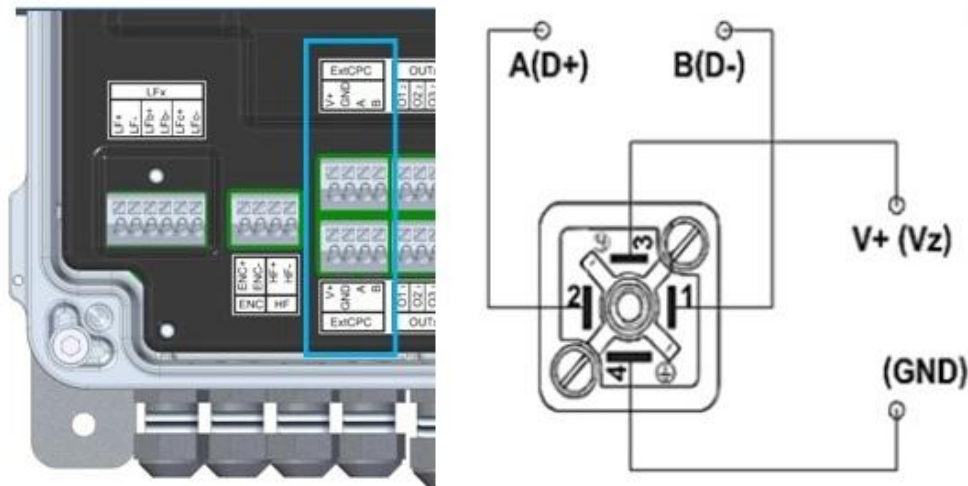

Figure 5.14 The connections of the CPC-03 pressure sensor to the CMK-03 converter clamps .

The clamps of the ExtCPC ports are doubled in the both terminal strips. This allows for easy, parallel connection for two cables to the electrical same ExtCPC port.

WARNING!

The CPC-03 converter should be connected by using the shielded cables. The cable shields should be connected from the converter side. The preparation method of the cables is presented in the Table 5.5.

WARNING!

It is obligatory to connect correctly the intrinsically safe circuits of the device. It is not allowed to connect to the CMK-03 clamps any external devices with undefined purpose.

For example: the connection of external power supply output (V+,GDN,A,B) with ExtCPC output of the CPC-03 external converter may occur permanent damage and loss of the intrinsically safe parameters.



The operating configuration is described in the part 11.2.7.

WARNING!

The proper cooperation between the CPC-03 external converter and the CMK-03 is possible with firmware version CPC-03 no. v. 13.11.27.08.

The CPC-03 with the older firmware will not working correctly with the CMK-03.



The firmware version of the CPC-03 can be checked by reading the name plate of CPC-03 in the Gaz-Modem2/3 protocol. This information is available as a “wersja prog” parameter in the DP Table. There is also possible to check the name plate by using CCTool program — after connection the firmware version will be displayed in the top part of the screen.

5.7 Connecting the LF input to the gas meter

The cable which provides pulses from the gas meter (carrying information about quantum of the measured volume) should be connected to the LF+ and LF- clamps of the LFx port.

The polarization is not significant in working mode with the reed-relay pulses transmitter. The polarization should be kept, in working mode with the electronic transmitter (e.g. Wiegand) with the polar OC output.

WARNING!

The LF+ and LF- clamps should be connected only by using the shielded cables with the maximum length to 10 meters (cable selection – see Table 5.3). The cables shields should be connected from the side of converter. The preparation method of the cables is presented in the Table 5.5.

It is allowed to keep connection between the LF cable shield with the plug of gas meter, by following conditions:

- the shield should be disconnected (insulated) from the cable gland in the CMK-03
- equal potential should be assure between the housing of the gas meter and the volume converter

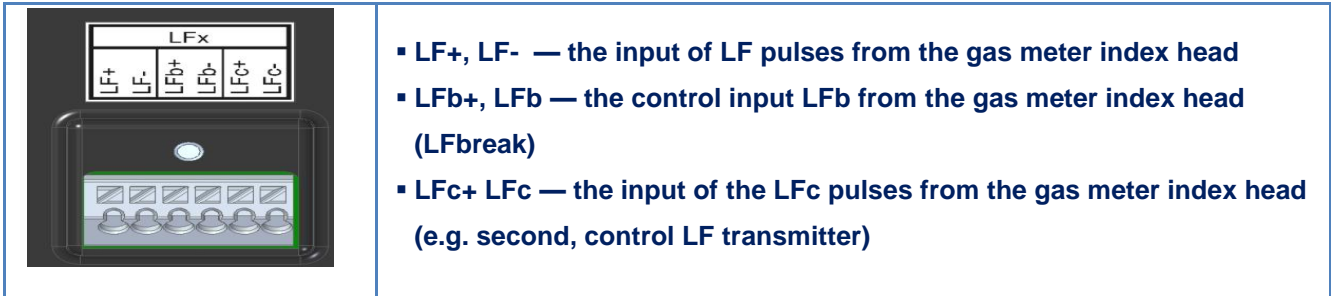

5.8 Mechanical installation of the CMK-03

The installation methods are described in the Appendix 1 – “The mechanical installation methods of the CMK-03”.

5.9 Battery

WARNING!

It is necessary to use the batteries according to the operating instruction. The batteries used in the CMK-03 can be disconnect and connect in the explosion hazard zone.



5.9.1 Main batteries.

The CMK-03 main power supply is a battery pack “BAT-03” Type (there are two installed batteries) manufactured by COMMON S.A. The batteries are marked as follow:

Battery type: BAT-03
Manufacturer: Common S.A.

The battery pack is ended with a cable which has a connector with a protection against the polarization. The placement method of the battery cable is free, but it should not cause a tension of the cables from plugs.

The batteries are connected to the internal sockets marked as **BAT1** and **BAT2**. The device has the battery self detect function what means that there is an automatically detection when battery is connected or disconnected.

The batteries are installed in the springy handles inside the housing cover (Figure 5.28).

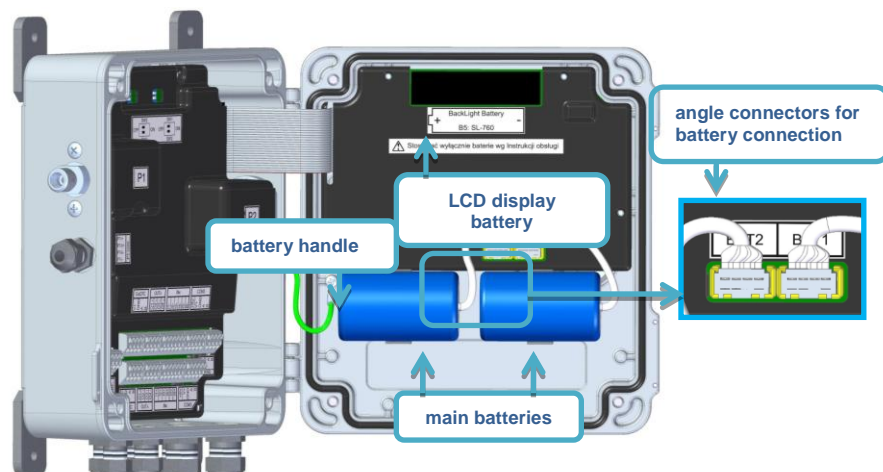

Figure 5.28 The battery installation.

The batteries can be factory sealed or sealed by the user after the replacement and after ending of the guarantee time.

The replacement of the main battery BAT1 and BAT2 does not break the seals and the metrological characteristic of the CMK-03.



The disconnection of the both main batteries does not cause a loss of the current and registered data.

The data are stored in a nonvolatile memory which does not require the power supply. The data saving is continuing till the voltage cut-off of the battery or the external power supply. There are saved all counters and data bases.

By the CMK-03 external power supply all of the functions are using only the external power and the main batteries are not in use.

The CMK-03 calculates in the real time a level of the battery usage. If the estimated battery working life time reaches the level lower than 10%, it will be registered an alerts in the bases: "Archive", "MID Alarms", and "Events". The alerts are presented on the LCD as a text: "Battery <10%" and "Battery<10%(MID:133)". In such case it is necessary to replace the battery on new.

The battery kit life-time is minimum 5 years in typical, defined working conditions which are defined as follows:

- lack of the external supply (V+, GND)
- frequency LF = 2Hz
- ta = - 25°C
- p1 = max range value
- t = min range value
- frequency of the measurements "p1" and "t" every 30 s
- p2...p4 – lack of converters
- LCD service < 5 minutes / 24 h

The battery status and the estimated life time are available on the LCD on one of the MID screens:

- **Etl** — the number of working days till the battery discharging
- **Bat** — the percentage battery status

This parameters are also available in the Gaz-Modem protocol.

5.9.2 Battery of the LCD backlight.

There is a separated AA size battery which supports the LCD backlight. The battery is installed in a handle under the device cover (see Figure 5.28). The backlight helps to read the data and operate the display in weak illuminated places. The backlight does not use the energy from main batteries and does not reduce their working life time. If the CMK-03 is working on the external power supply, the LCD backlight uses only this power source and the LCD battery is not in usage.

- **battery type approved to the usage: SL-760 Xtra or TL-5903 manufactured by Tadiran**
- **battery should be installed in a handle according to the polarization (+, -)**
- **false polarization will not cause a damage of the device or of the battery, but as result will be improper work of the LCD backlight**
- **false battery connection will not cause a loss of the intrinsically safe parameters of the device**

The replacement of the backlight battery, does not break the seals and the metrological characteristic of the CMK-03.

The battery can be sealed with the factory seal or user seal after the replacement and after the ending of guarantee time.



The life time of the backlight battery is approximately 80 hours of constant summary work. This time period can be shorter if the device will operate in the low temperatures, or there is a often, long usage of the backlight.

The battery operation time is approximately 2,5 year, if the LCD will work on the battery supply mode with active backlight during 5 minutes per day (24h). The backlight battery is not covered by the guarantee.

5.10 Conditions of safe usage

The CMK-03 converter should be used according to:

- purpose with the guidelines indicated in the operating instruction
- conditions included in the certificate **KDB 14ATEX0102X**
- standards and rules concerning installation and intrinsically safe systems.

The electrical intrinsically safe parameters – see part 4.33

The selection of cooperating devices must to fill the conditions listed in the Table 4.12 Conditions of the conformity of the intrinsically safe parameters.



The method of cable selection is described in part: 5.2 “Cables for the intrinsically safe circuits”



WARNING!

The hazard of electrostatic charges. The front cover of the device (elevation, keyboard, display window) is made of the synthetic material where can be accumulated the electrostatic charges. This surface may not be to rub with dry materials, so as not to cause the electrify effect and danger of discharge!



The connection between CMK-03 circuits (“ia” security level) with the other devices with “ib” security level implies a creation of the system which is on the lower “ib” security level (including the CMK-03).

6 Gas volume correction

6.1 Principle of operation

The CMK-03 converter sums the gas volume based on the LF pulses in measuring conditions V_m and also makes conversion of the gas to the basic conditions V_b based on:

- measured value of the absolute gas pressure p_1 ,
- measured value of the gas temperature t ,
- programmed gas composition or gas chemical and physical parameters,

The volume increase of gas in the measuring conditions is calculated as the product of the total number of dLF pulses and their value “ $waga_LF$ ”. In the next step the volume increase of gas is summed to the main counter:

$$V_m [m^3] = V_{m_{pop}} + dV_m$$

$$dV_m = dLF \cdot LF \text{ pulse value}$$

where:

- $waga_LF$ – quantum of the volume increase in measuring conditions in relation to one LF pulse
- dLF – pulses number increase
- dV_m – volume increase in the measuring conditions,

V_{mpop} – volume counter value in the previous state.

The calculations of proper parameters in basic conditions are made in case of:

- changing the gas composition/parameters
- changing the reference temperature **T_b**
- changing the reference pressure **p_b**
- initialization the converting module/device

The measurement of the gas temperature and gas pressure, the calculation of the parameters in the measuring condition and the designation of the **C**, **K1**, **Z** coefficients are made for every 30 seconds on the battery supply and for every 1 second on the external power supply working mode.

Additional:

- if there is no pulses from the gas meter during time longer than period of the measurements (30 sec. or 1 sec.), a mean value of the “**C**” coefficient is calculated for time-period which was without pulses.
- if first pulse will come in defined time interval this causes:
 - the pulse is counted to the **V_b/V_{b_e}** counter with mean value of the **C** coefficient correction.
 - the mean value of the **C** is initialized by the current value of **C_c** coefficient.
 - every next pulse is summed with new value of the **C** coefficient in defined time interval.

This rule of operating provides a higher, dynamical precision of the calculation, in the situation when the gas parameters are changing between **LF** pulses from the gas meter (a small flows).

The all counters (**V_m**, **V_b**, **V_{b_e}**, **E**, **E_e**) are updated for every incoming LF pulse and are refreshed on the display in every pulse or in every 1 second, regardless of the type of power supply mode (battery or external).

The volume increase in the basic conditions is calculated as product of the **dV_m** counter increase in the measuring conditions and the **C** correction coefficient, and then is summed to the main counter:

$$V_b [m^3] = V_{bpop} + dV_b$$

$$dV_b = dV_m \cdot C$$

where:

- C** – coefficient of the volume conversion
- dV_b** – volume increase in the basic conditions
- V_{bpop}** – value of the volume counter in previous state

The **Z_b** compressibility coefficient in the basic conditions and **Z** compressibility coefficient in the measuring conditions are determinate by one of the available calculating methods which is implemented in the converter.

CONVERSION PTZ – for algorithms: SGERG-88 and AGA8-92DC.

The **C** correction coefficient is calculated on the base of formula:

$$C = \frac{p}{p_b} \cdot \frac{T_b}{t} \cdot \frac{Z_b}{Z}$$

CONVERSION PT – for constant, programmable value of K1 coefficient

$$C = \frac{p}{p_b} \cdot \frac{T_b}{t} \cdot \frac{1}{K1}$$

where:

- K1** – relative compressibility coefficient

$$K1 = \frac{Z}{Z_b}$$

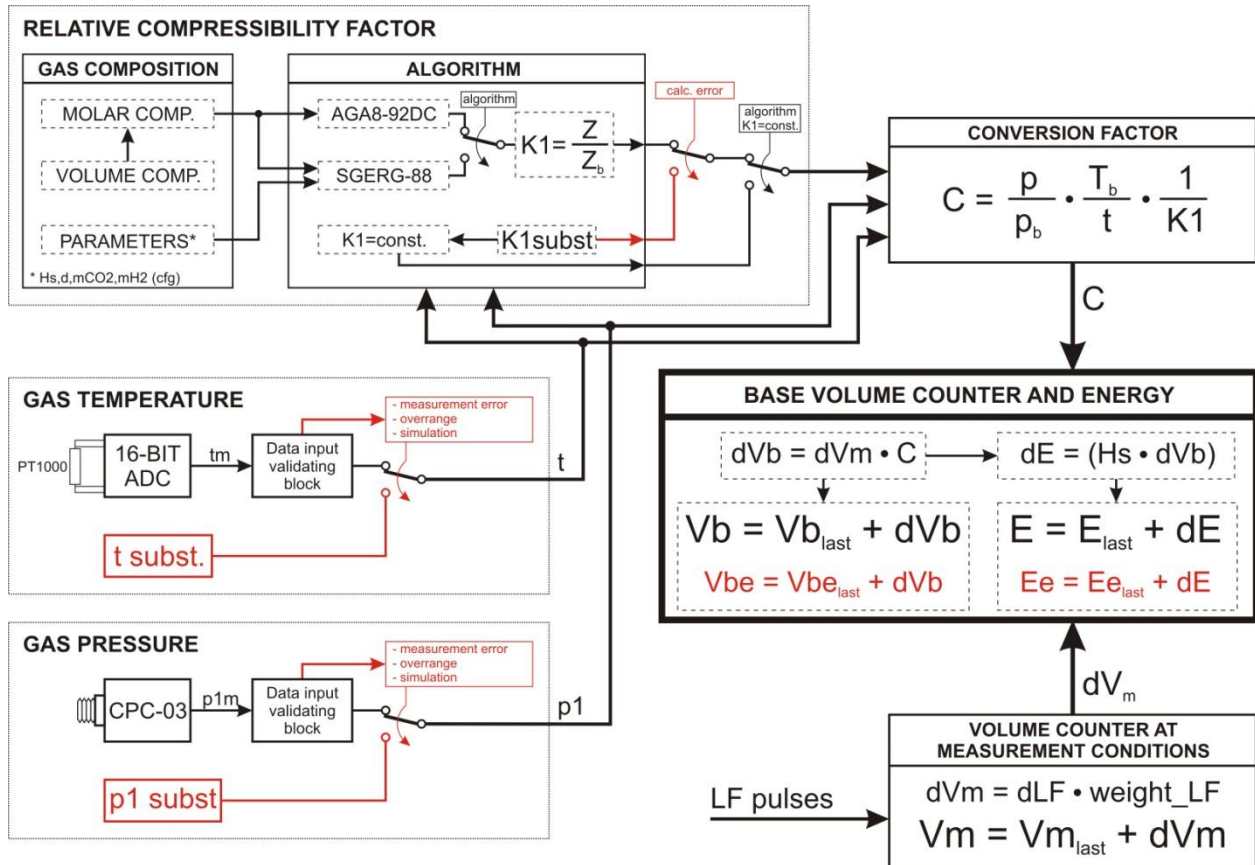

Figure 6.1 CMK-03 operating rules — flowchart

6.2 Algorithms

The CMK-03 converter has implemented a calculating methods as follows:

- SGERG-88
- AGA8-92DC
- “K1=const”

For the **SGERG-88** method there are incoming data (which define gas mixture) as follows:

- detailed molar gas composition (37 component), or
- detailed volumetric gas composition (37 component), or
- gas parameters (**Hs**, **d**, **CO2** (molar), **H2** (molar)).

For the **AGA8-92DC** method there are incoming data (which define gas mixture) as follows:

- detailed molar gas composition (21 component), or
- detailed volumetric gas composition (21 component)

For the **“K1=const”** method there is no necessary to define the gas composition. The K1 coefficient is equal with the **Z/Zb** ratio. The conception of this method is to use the CMK-03 on a bio-gas station or others stations where the gas components exceed applicability ranges of the implemented calculating methods in the converter, and operating pressure does not exceed determinate value.

If there is known a gas specification, there is possible to define the relative compressibility coefficient based by means of:

- algorithm implemented in the converter (if it will be a solution),
- different proper calculating method,
- built-in “biogas calculator” in the CCTool software.

The such defined value of the relative compressibility coefficient, may be use to the volume correction.

The **“K1=const”** method has a limits which were defined to restrict the calculating error to the value not bigger than 0,25%. In case of:

- $K1 = 1$, gas pressure has to be lower than 1.5 bars abs.
- $K1 = \text{const. but } K1 \neq 1$, gas pressure has to be lower than 11 bars abs.

It is necessary to define the permissible measuring limits of gas and temperature, to observe the error caused by $K1$ constant value in relation to the changing values of the temperature and pressure. The observed error should not be greater than 0,25%.

To define the mentioned limits should be used the dedicated parameters: **Limit t** for $K1=\text{const}<>1$ and **Limit p1** for $K1=\text{const}<>1$ (available in the **CCTool** configuration software).

6.3 Bio gas configuration

The CMK-03 converter is a **MID device**. The algorithms such as AGA8 or SGERG-88 (approved according to the standard) have a limits of the incoming parameters value. This limits do not allow to define a value of the compressibility coefficient for gases and their mixtures which are out of range of the approved applicability. Accordingly to it, there is provided the programming option (**MID** – metrological controlled) of the constant relative $K1$ compressibility coefficient.

The configuration on the bio gas working mode:

- the $K1$ coefficient can be programmed on value $K1=1$, on a gas stations where operating pressure $\leq 1,5$ bars abs and there are unknown details of the gas composition. It can be set by using LCD or CC Tool software. Additionally the converter should contain the programmed value as follows:
 - correct **Hs** heat combustion value to the proper energy indication. The **Hs** heat combustion value oscillates typically for bio-gas in ranges $15...21\text{MJ/m}^3$ ($4,1...5,8\text{ kWh/m}^3$).
 - correct **d** relative density value allows for proper calculation of the mass stream and **W** Wobbe's number.
- the $K1$ coefficient values $K1<>$ and additional measuring limits for pressure "**p1**" and temperature "**t**" can be determinate by using a "**Bio-Gas Calculator**" in the **CCTool** program on a gas stations where the operating pressure is on level ≤ 11 bars abs, and there are known the details or parameters of the gas composition. The determinate values should assure an error caused by **p1** and **t** on the level not greater than $\pm 0,25\%$. The Bio Gas Calculator designates also the value of **Hs** heat combustion and the value of **d** gas relative density. There is also possible to enter this values manually.

The $K1=\text{const}<>1$ determination procedure by using the CCTool program:

1. connect with the device
2. select bookmark "Gas composition"
3. select "Bio gas calculator"
4. enter the gas composition or parameters
5. enter the average values of the gas pressure and gas temperature in measuring installation according to the example as below:
 - if the temperature is in typical range from 20°C to 30°C , the temperature value should be set on 25°C
 - if the over-pressure range in the installation is from 60 to 140 mbar (6 to 14 kPa) the pressure value should be set on 100mbar (10kPa) over the average atmospheric pressure e.g. 110 kPa abs.
6. select "Calculate $K1$ ". It will be determine 3 values of the **K1** coefficient.
 - a. **K1** which is corresponding with the average values of **p1** and **t**,
 - b. **K1'** which is corresponding with the bottom pressure range and the top temperature range (conditions for maximum value of the **K1** coefficient)
 - c. **K1''** which is corresponding with the top pressure range and the bottom temperature range (conditions for minimum value of the **K1** coefficient)

If there is fulfilled condition: $\Delta K1' < 0,25\%$ and $\Delta K1'' < 0,25\%$ for the selected gas and initially set ranges of the **p1** and **t**, the converter can be programmed by using "**set**" button. After this operation there are set parameters as follows:

- $K1=\text{const}$ algorithm,
- gas composition (information),
- gas parameter: Hs, d, mCO_2 ,

- calculated **K1** value,
- determined limits for **t** and **p1**

The set parameters should be sent (record) to the CMK-03.

There are deviations of the **K1'** and **K1''** values for selected gas and initially set ranges of limits for **p1** and **t**. If those deviations are bigger than +/- 0,25% in comparison to the middle value of **K1**, the limits of **p1** and **t** should be narrow down till the values which correspond with the real conditions on the operating station or it should be selected the mean values of **p1** and **t**. The limits value which are suggested by the program are very wide.

The **t** temperature is typically on level approx. 20°C or 30°C for a bio-gas but program assumes initially **t** value from 10°C to +40°C. The limits are adjustable and can be set as they are on the real existing gas installation. If the set limits will be too narrow, it can cause that the volume values will be counted in to the emergency counter in case of the **t** crossing over the programmed limits.

If there are exist the designated gas parameters (**Hs**, **d**) mentioned in delivered gas specification, it is possible to enter them manually.

The **Hs** heat of combustion value is presented in a different units (**MJ/m³** or **kWh/m³**):

$$1 \text{ [MJ/m}^3\text{]} = 3,6 * 1 \text{ [kWh/m}^3\text{]}$$

$$1 \text{ [kWh/m}^3\text{]} = 1 \text{ [MJ/m}^3\text{]} / 3,6$$

Table 6.1 Examples of the 'bio-gases' compositions

Examples of the 'Bio-gases' compositions (volume shares)					
example 1		example 2			
methane	– CH4	51,89%	carbon dioxide	– CO2	57,2%
carbon dioxide	– CO2	35,75%	methane	– CH4	35,0%
nitrogen	– N2	12,37%	hydrogen	– H2	4,0%
oxygen	– O2	0,01%	hydrogen sulfide	– H2S	3,0%
heat of combustion	– Hs	20,62 MJ/m ³ 5,727 kWh/m ³	oxygen	– O2	0,5%
relative density	– d	0,9420	nitrogen	– N2	0,3%
gas temperature approx. 20 ... 30°C					
gas pressure approx. 60... 140mbar (6... 14kPa) above atmospheric pressure					
gas flow approx. 150m ³ /h					

7 Energy conversion

The energy conversion is based on the formula:

$$E[\text{kWh}] = E_{\text{pop}} + dE, \text{ where } dE = (Hs/3.6) \cdot dV_b$$

where:

- **E_{pop}** – the value of energy counter from the previous state
- **dE** – calculated energy increase
- the numerical coefficient 3,6 which is a result of the units conversion:

$$1[\text{MJ}] = 1[\text{MWs}] = 10^3[\text{kWs}] = 10^3[\text{kW}] \cdot \frac{1}{3600[\text{h}]} = \frac{1}{3600} [\text{kWh}]$$

- **Hs** – heat combustion value included reference T1 temperature
- **dV_b** – volume increase value in basic conditions

The energy increase calculation and the counter actualization are made for every LF pulse incoming from the gas meter.

The unit **MJ/m³** is default for **Hs** parameter in the converter. The **Hs** value conversion per unit kWh/m³ is following:

$$1 \text{ MJ/m}^3 = 3,6 * 1 \text{ kWh/m}^3$$

Important! The algorithms which calculate the value of **Hs** heat combustion, take into consider the **T1** temperature (parameter) as a reference temperature of the combustion process. The T1 parameter is typically equal 25°C (298,15 K) and is configurable.

8 Metrological marking, protection seals, name plates

8.1 Metrological marks – Seal 1 and Mark IV

The unique type, self-adhesive labels are used as a metrological seals. The labels are made of the special, holographic material with a laser burned mark according to the pattern presented below. Seals are highly adhesive, durable and resistant to environmental conditions. By the attempt of interference they remain permanent mark – word “VOID” on the token off seals foil. There is impossible to place again once removed seal.



scale 2:1; real size: 10 x 20 mm

Figure 8.1 Pattern of the metrological marking

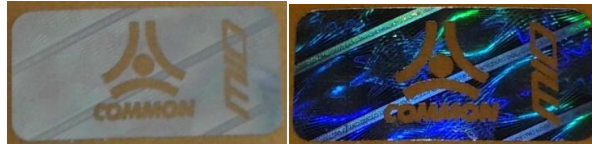

Figure 8.2 View of proper metrological mark



Figure 8.3 view of broken metrological mark

The marking label is placed on the front surface of device after the primary verification – see Figure 8.4



scale 2:1; real size: 20 x 20 mm

Figure 8.4 patten and view of primary verification marking

8.2 Manufacturer protective seals – Seal 2

The manufacturer protective seal is placed as a type of fragility seal.



scale 2:1; real size: 20 x 20 mm

Figure 8.5 Pattern of the manufacturer protective seal

It is possible to use equivalently manufacturer seals with a different, approved pattern.

8.3 User protective seals – Seal 3

The CMK-03 construction predicts the places dedicated for a user protective seals (see Figure 8.13). User is obligated to place the protective seals after device installation. They should be placed after control of the device mechanical installation and electrical connection what should be done accordingly to this operating instruction and other safety rules.

8.4 Marking of name plate

The label pattern and the name plates are presented below:

<p>Electronic Volume Converter CMK-03</p> <p>Pressure p1: 0.5 ÷ 3 bar A Temperature t: -25°C ÷ 65°C Pressure p2: 0 ÷ 6 bar G</p> <p>ECD MPE: Class A Hs: 20 ÷ 48 MJ/m³ (at T1=25°C) Environmental class: O</p> <p>CE M15 1450 1453 MPE=0.5% -25°C ≤ Ta ≤ 55°C, M2 / E2 IP66/67 PL-MI002-1450CQ0001</p> <p>II 2G Ex ia IIB T4 Gb KDB 14ATEX0102X PN-EN12405-1+A2:2010 PN-EN 12405-2:2012</p>	<p>Example of the “MID” metrological plate</p> <p>The two last numbers which are located in a rectangle field after M letter, identify the year of converter primary verification. In this case there is number ‘15’</p> <p>The p1 and p2 pressure ranges are corresponding to the version of execution</p>
<p>Electronic Volume Converter</p> <p>Type: CMK-03 Serial No.: 1537001 Mfg. date: 2015-09-07 Order code: CMK-03/3A/12/6G/12/1650/C/S/M/PL</p> <p>COMMON S.A. ul. Aleksandrowska 67/93 91-205 Lodz, PL Made in Poland</p>  <p>(01)05907715207012(11)150907(21)1537001</p>	<p>Example of the metrological plate with data and “KOD” bar code</p> <p>The fields such as: “serial number”, “date of production”, “code of product” contain the information which identify every unit of the CMK-03</p>

The “MID” plate is placed on the device front and “KOD” plate on the top side. Plates are protected with the metrological marks (Fig 8.6 and Fig. 8.7).



Figure 8.6 MID plate – placement



Figure 8.7 “KOD” plate - placement on housing

The plate position may be slightly different from presented above. The “KOD” plate may be placed on the front, next to “MID” plate.

<p>COMMON Termometr Pt1000/A/4/-30/70</p> <p>Typ: CTA4-0512 Nr fabr.: 1226238</p>	<p>The CTA4 thermometer name plate</p> <p>The thermometer is metrological combined with the converter in phase of the primary verification. The name plate is located on the cable.</p> <p>The numbers which are printed after “CTA4” symbol, specify the thermometer parameters according to the CODE(5).</p>
<p>Digital Pressure Transmitter CPC-03e</p> <p>Type: (0.9-6)bar abs Serial No.: 1348009 Mfg. date: 2014-04-08 Order code: CPC-03/6A/e12/-</p> <p>COMMON S.A. ul. Aleksandrowska 67/93 91-205 Lodz, PL Made in Poland</p>	<p>The name plate of the CPC-03e p1 external converter</p> <p>The CPC-03e pressure converter is metrological combined with the CMK-03 in phase of the primary verification.</p>

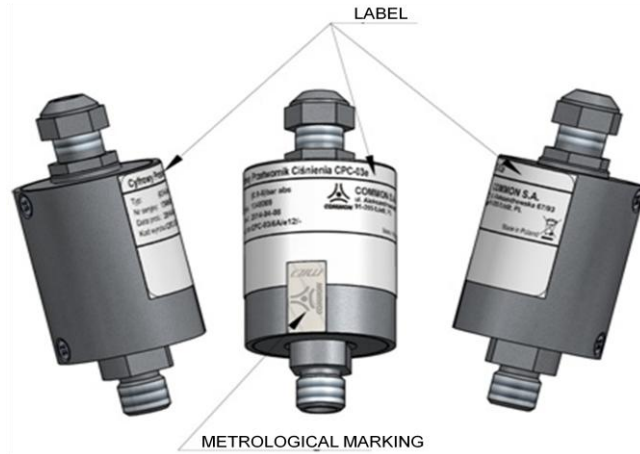

Figure 8.9 The positioning and sealing of the CPC-03e name plate

8.5 Seals placement inside the housing

The seals localization inside the CMK-03 housing is presented in the Figure 8.10. There are three types of the mechanical protective marking.

TYPE OF PROTECTION	SEALING SYMBOL	
primary verification mark (Initial Verification)	Mark I.V. 	
metrological protective mark	Plomba 1 	
manufacturer seal	Seal 2 	
user seal	Seal 3	

The metrological marks are placed on the instrument after:

- phase of primary verification
- metrological certification according to approved type
- admission to an accounting functions.

The manufacturer seals protect against an unauthorized access to the operating and maintenance areas of device.

The user seal should be placed on the device as a protection against access and interference into the measuring signals or technological functions such as: LF signal input clamps, PT1000 temperature sensor input clamps, the housing closing place after finished installation, the pressure or temperature connection places.

Damage of any of the above protective marks results as follows:



- a loss of the credibility characteristic as a measuring-accounting instrument



- a loss of the manufacturer guarantee and intrinsically safe characteristic



- signal of the unauthorized interference in the measurement system

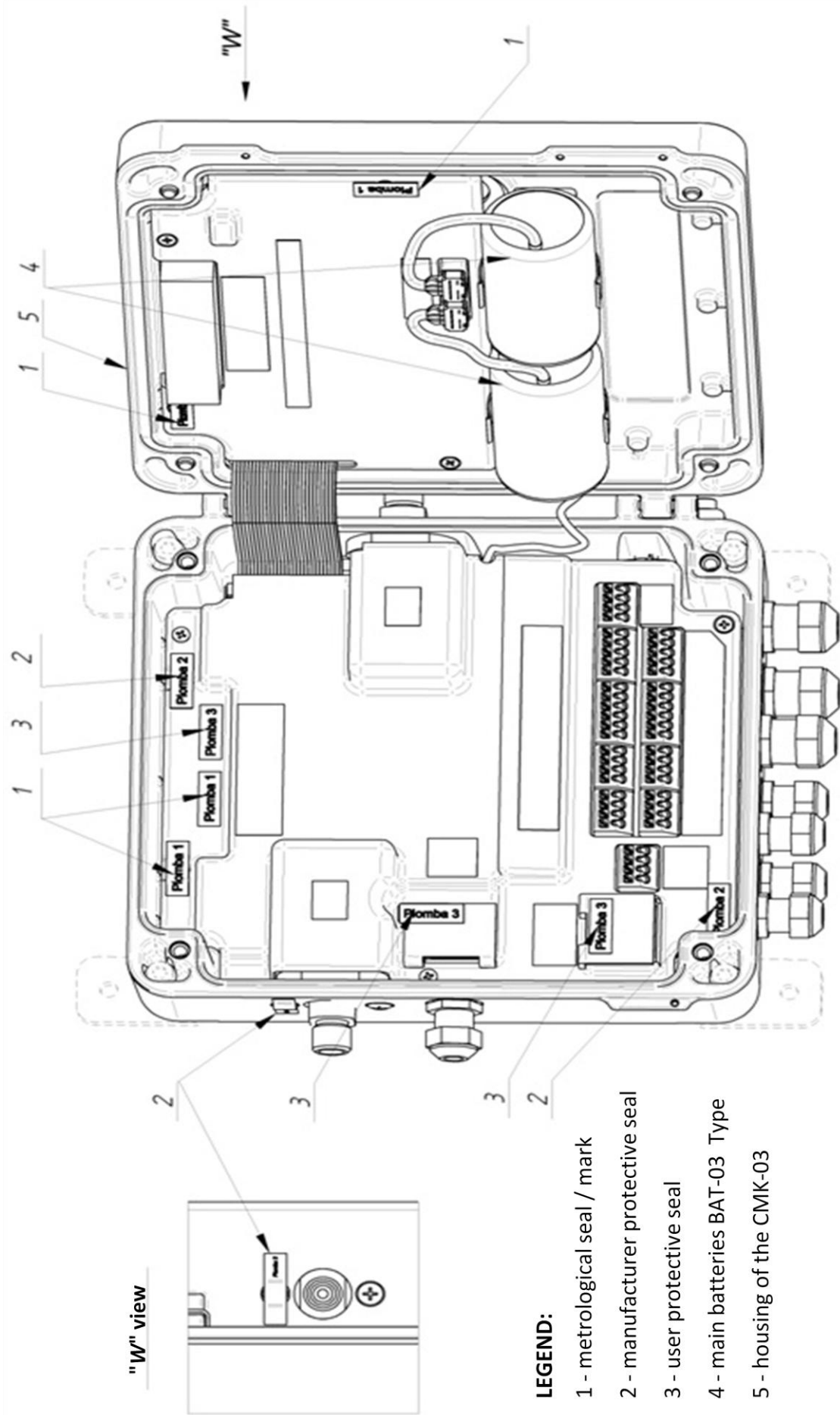

Figure 8.11 The sealing inside the CMK-03 housing

8.6 Internal software identification

The CMK-03 internal software is divided on two parts.

The metrological part is significant for the measurement result and is checked and approved during a laboratory tests of certification process. It is marked with the **SV** symbol, the number of version and the **CRC** control sum.

The technological part is not combined with the converter main functionality. This part has no affect on the measurement result. It is out of the metrological control and can be develop and modify by the manufacturer according to his Quality Management System. The technological part is marked with the **FV** symbol and the number of version. The information regarding the software version are presented on the one of MID displays.

CMK-03
 impLF = 1.00 m³
 Et1: 2115days Bat: 96.6%
 SN: 1610005
 FU: 2.2.37-2.7.5
 SU: 1.4-1.2
 CRC: B0ADC36A-BDBB2F94
 2016/05/31 10:27:46

FV:	2.35 - 2.7.3	Firmware Version – software for <u>technological part</u>
SV:	1.4 - 1.2	Software Version – software for <u>metrological significant part</u>
CRC:	B0ADC36A - BDBB2F94	CRC – the counted control sum from the parts of metrological significant programs

The volume converter which is under control of the metrological law must have the SV software version and CR control sum, which are conformed with the certificate of type test data or future supplementation to the certificate.



The firmware update of the technological part may be performed by the manufacturer service or authorized manufacturer representative on the production and operation stage. The update does not require to remove the metrological seals and does not change the metrological properties of device. The firmware update requires authorization with the user password (the password is settable in the menu).

The update process is recorded every time in the internal “Events” register.

9 MID alarms

9.1 Principle of operation and list of alarms

The CMK-03 controls the correctness of values for all parameters incoming to the volume correction algorithm, both measurement results and configurable algorithm parameters in a real time.

If there is an overflow of the converter measuring ranges, or an overflow of the applicability range or a change in the metrological parameters which affect on the metrological result, then it occurs as follows:

- alarm occurrence signal by flashing the icon  on the top bar of the display main screens
- the alarm registration with parameters in the **MID Alarms register**.
- stopping of the volume counting to the **Vb** counter (in case of alarms and permanent overflows)
- start of the estimated basic volume counting to the **Vbe** emergency counter.

Table 9.1 List of MID alarms – metrological significant

ALARM CODE	ALARM MESSAGE REGISTERED PARAMETERS	ALARMS REASON - DESCRIPTION	COUNTING TO <u>Vbe</u>
PERMANENT ALARMS (CONTINUING IN TIME)			
0	p1 out of range p1, Vb	overflow of the p1 pressure measuring range	YES
1	t out of range	overflow of the t temperature measuring range	YES

ALARM CODE	ALARM MESSAGE	ALARMS REASON - DESCRIPTION	COUNTING TO <u>Vbe</u>
	REGISTERED PARAMETERS		
	t, Vb		
2	Alg. Z range exceeded p1, t, Z, , Vb	overflow of algorithm applicability range of the Z compressibility coefficient designation.	YES
3	p1 transduc. failed p1, Vb	damage or lack of the p1 pressure converter	YES
4	t transduc. failed t, Vb	damage or lack of t temperature sensor	YES
5	Subst. val. K1 alarm p1, t, K1, Vb	overflow of algorithm range what causes with lack of the algorithm solution (to calculation is used the K1 substitute value)	YES
6	p1 subst. val. on p1, p1zast, User, Vb	authorized user has enabled the p1 alternative value (to check measuring track procedure)	YES
7	t subst. val. on t, tzast, User, Vb	authorized user has enabled the t alternative value (to check the measuring track procedure)	YES
TEMPORARY ALARMS			
128	Vb count. overfl.	Vb counter has reached maximum value and has started to count from 0 value	NO
130	Conf. changed USER, Vb	authorized user has changed configuration of the metrological significant parameters	NO
131	Usage > 70% Vb	MID alarms register is filled in over 70 % (unsigned alarms and/or on-going alarms)	NO
132	Database full Vb	MID alarms base is full in 100%. The counting is continued to the Vbe. There is impossible to change the configuration of MID parameters. The acknowledge is necessary for further converter working process.	YES
133	Alarms acknowld. User, Indeks ZMS, Vb	authorized user has acknowledged the alarms	NO
134	Battery < 10% Etl, Vb	it remains less than 10% of the main battery estimated life time	NO
135	New program FV, SV, CRC	authorized user has updated the firmware	NO

The **MID alarms register** has a capacity for a minimum 256 records, which are stored in the nonvolatile FLASH/FRAM memory. The MID alarms base is a rotary register what means that during saving operation the oldest records are deleted and overwritten with the new entries.

The every record of MID Alarms Register is presented on the display and it contains:

- ZM record unique index
- alarm code and short alarm message (e.g. "(1) – p1 range overflow")
- data and time of the alarm recording (for temporary alarms)
- data and time of the alarm beginning and end (for permanent alarms)
- registered parameters – values of the presented figures which are stored in the moment of alarm occurrence
- confirmation symbol – \surd – if it is executed

The deleting of the oldest alarms is possible only when the following condition are respected:

- the all alarms (records) are acknowledged in the oldest sector
- the all permanent alarms are completed in the oldest sector

If the **MID alarms data base** is filled in 100% then occurs a limited work possibilities of the converter – in such situation the volume is counted to the **Vbe** emergency counter and to the **Ee** energy counter. The possibility of the configuration parameters changing is locked. Restore to fully functionality will occur after ending and acknowledgment of the permanent alarms.

9.2 Signaling, authorization and alarms acknowledgement

The every new alarm which is stored in the MID alarm register, causes the appearance of the flashing  icon on the top bar of main display screens. This means the occurrence of new, un-acknowledged alarms.

The alarm acknowledgment requires an authorization — the selection of the user account and the password. The correct log-in operation causes the alarm acknowledgment from the oldest till latest. It will be also recorded an information about the acknowledgement execution with the number of user account and **ZMS index** of the last acknowledged alarm.

It is possible to acknowledge permanent, opened alarms (still on-going).

If icon  is active (flash constantly without pulsing), it means that the all alarms are acknowledged, but the alarm conditions still occur (at least one of the permanent alarms is still open).

The signaling MID alarms icon is disable, if the all alarms are acknowledged and all permanent alarms are ended. The alarm conditions are stopped.

The login time maintenance is equal 3 minutes and is counted form the last user activity on the operating display (except of the “Light” button). After this period of time a user will be automatically logged out.

The logout operation follows also:

- after manually LCD display switching off what occurs after the multiple pushing ESC button
- after LCD activity time running out — this parameter is configurable in the option: **Settings→LCD→Act. time.**

The login status is presented as a “**Log:0**” symbol on the bottom bar of the display, where 0 means number of the logged user.

The login continuation status does not occur on the remote control working mode (Gaz-Modem 2/3 protocol communication channels). In this case the authorization is required by every transmitted modification or acknowledgement.

Local Acknowledgement

The option is available in the LCD menu: **Main Menu→ Archive → MID Alarms → Acknowled.**

Remote Acknowledgement

The DP Table contains parameters:

- “ZM index” – an unique index of the last registered MID alarm
- “ZMS index” – an unique index of the last acknowledged MID alarm

The modification and recording of the “Index ZM” parameter on the value 0 (zero) occurs an acknowledgment of the all alarms. The correct authorization is required.

9.3 Operating principles in the Vbe emergency conditions

If there is **p1** pressure overflow greater than permissible measuring range but the converter is still working in the possible measuring ranges (indicates the value), then volume estimation follows to the **Vbe** emergency counter based on the **p1** actual value.

If there is **p1** pressure overflow greater than measuring possibilities of the converter, or converter is damaged and does not response with the numerical value, then volume estimation follows to the **Vbe** emergency counter based on the **p1zast** alternative value. The **p1** value is presented on the MID screens with the substitute value and graphical symbols which are described in the **Part 11.1 LCD menu structure.**

The edged value of the measuring range or the information **NaN** with the proper status is displayed on the screen **Value measurement** (‘p1m’ parameter from DP Table) in the menu: **Main Menu → Measure → Press.P1.**

If there is **t** temperature overflow bigger than applicability range of the calculating algorithm, and indication is still in the converter range, than volume estimation follows to the **Vbe** emergency counter based on the actual indication of the **t** temperature converter.

If there is a **t** temperature overflow greater than converter measuring possibilities, or it occurs a damage of sensor or temperature converter, than volume estimation follows to emergency counter based on the **tzast** alternative value. The results presentation is analogical as in case of the p1 pressure.

If the calculating algorithm will find:

- uncorrect gas composition / gas parameters out of the applicability range
- **p1** pressure out of the applicability range
- **t** temperature out of the applicability range
- an overflow of the indirect parameters calculated value,

but there is still an algorithm solution, than the volume estimation follows to the **Vbe** emergency counter based on the **K1** coefficient value, which is calculated by means of this algorithm.

If there is no algorithm solution (by a selected calculating algorithm), the volume estimation follows to the **Vbe** emergency counter based on the **K1zast** alternative value.

In case of the $K1 = \text{constant}$ working mode, the volume estimation to the **Vbe** counter and emergency conditions will occur if:

- for $K1 = \text{const} = 1$ → after **p1** pressure overflow ($p1 > 1,5$ bar abs), or **t** temperature out of the converter range $-25^{\circ}\text{C} \div 65^{\circ}\text{C}$,
- for $K1 = \text{const} < 1$ → after **p1** pressure overflow or **t** temperature out of the programmed limits “**Limit p1 for $K1 = \text{const} < 1$** ” and “**Limit t for $K1 = \text{const} < 1$** ” (the parameters of the bottom and top limits: dlp1K1, glp1K1, dltK1, gltK1 are available in CCTool software; in Gaz-Modem 2/3 protocol and in DP Table).

All of the overflows, which cause an emergency conditions, are registered in the “**MID Alarms**” and signaled by the occurrence of flashing icon  on the top bar of main MID screen.

10 MID interferences (configuration changes)

10.1 Principle of operation and list of parameters

The modification of the configuration parameters results with a record saving to “**MIDregist.**” interference register. The saved record contains the parameters combination and their changed values. In a Table 10.1 are shown the parameters which affect on the measurement result and also the parameters which are saved to the interference register.

Table 10.1 Parameters recorded in the interference register

SYMBOL OF PARAMETER IN DP Gaz-Modem 3	SYMBOL ON LCD	NAME OF PARAMETER
impLF	LF weight	LF pulse value
Tb	Tb	base temperature
SymCfg	Simulation	activation of simulation for alternative values P1 and T
Tzast	Tzast	alternative value of gas temperature
P1zast	P1zast	alternative value of gas pressure
K1zast	K1zast	alternative value of K1 coefficient
algorytm	Algorhythm	algorithm type for a calculation of compressibility coefficient
CFG2	Algorhythm data	Type incoming data for an algorithm (parameters and, components)
CFG1	Gas comp.	type of the components concentration share in a gas mixture (by mole and by volume)
CH4	CH4	methane
C2H6	C2H6	ethane
C3H8	C3H8	propane
n-C4H10	n-C4H10	n-butane
i-C4H10	i-C4H10	i-butane
n-C5H12	n-C5H12	n-pentane
i-C5H12	i-C5H12	i-pentane

neo-C5H12	neo-C5H12	neo-pentane
C6H14	C6H14	n-heksane
C7H16	C7H16	n-heptane
C8H18	C8H18	n-oktane
C9H20	C9H20	n-nonane
C10H22	C10H22	n-dekane
C2H4	C2H4	ethylene
C3H6	C3H6	propene
i-C4H8	i-C4H8	i-butene
cisC4H8	cisC4H8	cis-2-butene
C4H8	C4H8	isobutene
1-2C4H6	1-2C4H6	1,2-butadiene
1-3C4H6	1-3C4H6	1,3-butadiene
1-C5H10	1-C5H10	1-pentene
C5H10	C5H10	cyclopentane
C6H6	C6H6	benzene
C7H8	C7H8	toulene
CH3OH	CH3OH	methanol
H2	H2	hydrogen
H2O	H2O	steam
H2S	H2S	hydrogen sulfide
CO	CO	carbon monoxide
He	He	helium
Ne	Ne	neon
Ar	Ar	argon
N2	N2	nitrogen
O2	O2	oxygen
CO2	CO2	carbon dioxide
SO2	SO2	sulphur dioxide
AIR	Air	air
Hs cfg	Hs	heat of combustion
d cfg	D	relative density (configurable)
CO2 cfg	mCO2	molar proportion of carbon dioxide (configurable)
H2 cfg	mH2	molar proportion of hydrogen (configurable)

10.2 Signaling, authorization and alarms acknowledgment

If it will be change any parameters of data, which have affect on a measurement result and this change will be authorized via user password, the converter will record a temporary alarm in **MID alarms** register with code: "130" and message "configuration change".

This operation will cause the occurrence of flashing icon  on the top bar of display main screens. There is require to acknowledge this alarm by an authorized user.

11. Local service

11.1 LCD menu structure

The CMK-03 is equipped in the LCD graphical screen with a backlight and an adjustable contrast. The display is operated by using the 7 buttons keyboard which allows for an information scrolling or parameters configuration. The main buttons functions are listed below:

ESC – exit to upper level, cancel of changes

 – scrolling / switching left

 – scrolling / switching up

 – scrolling / switching down

– scrolling / switching right

ENT – enter to lower level, acceptance of changes

– screen backlight

The main screen displays the basic accounting values as follows:

<p> CMK-03 Vm = 00000000000.01 m³ Vb = 00000009677.220 m³ Vbe = 00000000011.545 m³ E = 113271.120 kWh Ee = 132.008 kWh 2016/05/31 10:33:51 </p>	<p>Vm – volume counter in the measuring conditions. Counter must be set on the value accordant to the gas meter counter (description below)</p> <p>Vb – gas volume counter in the basic conditions (value after calculation)</p> <p>Vbe – gas volume counter in the basic conditions when occurrence the emergency conditions</p> <p>E – energy combustion counter</p> <p>Ee – combustion emergency counter in emergency conditions</p>
--	--

The main indication of the measurement such as: volume counter in the basic conditions, and others indications and significant parameters from metrological point of view, are displayed on the several main screens which are marked with icon (named as MID screens). The scrolling between the further MID screens is possible by using :

<p> CMK-03 p1 = 0.9864bar 0.9 ÷ 6 bar S/N:1607004 t = 27.96 °C -25 ÷ 65 °C S/N:160109 2016/05/31 10:33:58 </p>	<p>p1 – gas pressure (absolute). Below are listed: operating ranges and converter serial number.</p> <p>t – gas temperature. Below are listed: operating ranges and converter serial number.</p>
--	--

<p> CMK-03 Algorithm SGERG-88, mol. prop Alg. status: OK (0x0000) pb = 1.01325bar Tb = 273.15K C = 0.879768 K1 = 1.000962 Z = 0.997757 Zb = 0.996798 2016/05/31 10:34:04 </p>	<p>Algorithm – actually set calculating algorithm of the compressibility coefficient and a type of the gas composition (molar / volume or from parameters)</p> <p>Alg. status – calculating method status (description in farther part of the operating instruction)</p> <p>pb; Tb – basic conditions 1.01325bar ; 273.15K</p> <p>C – coefficient of the conversion to the basic conditions</p> <p>Z – compressibility coefficient in the measuring conditions</p> <p>Zb – compressibility coefficient in the basic conditions</p> <p>K1 – relative compressibility coefficient Z / Zb</p>
--	---

<p> CMK-03 CH4 = 85.9000% C9H20 = 0.0000% C2H6 = 0.5000% C10H22 = 0.0000% C3H8 = 2.3000% C2H4 = 0.0000% n-C4H10 = 0.3500% C3H6 = 0.0000% i-C4H10 = 0.3500% i-C4H8 = 0.0000% n-C5H12 = 0.0500% cis-C4H8 = 0.0000% i-C5H12 = 0.0500% C4H8 = 0.0000% neo-C5H12 = 0.0000% 1-2C4H6 = 0.0000% C6H14 = 0.0000% 1-3C4H6 = 0.0000% C7H16 = 0.0000% 1-C5H10 = 0.0000% C8H18 = 0.0000% C5H10 = 0.0000% 2016/05/31 10:34:11 </p>	<p> CMK-03 C6H6 = 0.0000% Ne = 0.0000% C7H8 = 0.0000% Ar = 0.0000% CH3OH = 0.0000% N2 = 1.0000% H2 = 0.0000% O2 = 0.0000% H2O = 0.0000% CO2 = 1.5000% H2S = 0.0000% SO2 = 0.0000% CO = 0.0000% Air = 0.0000% He = 0.0000% Hs = 43.524781MJ/m³ mCO2 = 0.015000 d = 0.649827 mH2 = 0.000000 2016/05/31 10:34:17 </p>	<p>the percentage gas composition, and displayed the all gas components and the gas coefficients</p>
---	---	--

<p> CMK-03 impLF = 1.00 m³ Et1: 2115days Bat: 96.6% SN: 1610005 FV: 2.2.37-2.7.5 SU: 1.4-1.2 CRC: B0ADC36A-BDBB2F94 2016/05/31 10:27:46 </p>	<p>impLF – set LF pulse value</p> <p>Et1 – estimated converter operating time on the battery set, when occurs a constant working conditions</p> <p>Bat – percentage batteries status</p> <p>SN – converter serial number</p> <p>FV – firmware version of the <u>technological part</u></p> <p>SU – software version of the <u>MID metrological part</u></p>
--	---

	CRC – control sum of the MID software part
--	---

The presentation of the measuring range overflow and an usage of the alternative value instead of **p1** and **t** is shown on the screen by using symbols “!” and “#” as follows:

sign	“=”	correct measurement value
flashing sign	“= / !”	value from the converter is out of measuring range, processing alarm
flashing sign	“# / !”	lack of the value, system alarm, used alternative value
sign	“#”	simulation activated, used alternative value

The example screen with presented overflows:

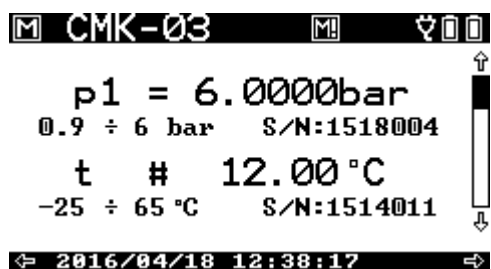

The symbols which used for the calculated **K1** coefficient:

sign	“=”	correct value
flashing sign	“= / !”	value out of measuring range, process alarm
flashing sign	“# / !”	lack of value, system alarm, used alternative value

The information about the **Status.alg.** status of operating algorithm is presented on the third MID screen. There are two possible states “OK” or “ERROR” with a proper error code. The error codes of the algorithm are shown in Table 11.1.

Table 11.1 Calculating algorithm – error codes

ALGORITHM	CODE	DESCRIPTION	INTERRUPT K1 CALCULATION K1 == K1zast
SGERG – 88	0x0000	correct calculations	NO
	0x0001	error of gas composition	YES
	0x0002	lack of solution	YES
	0x0004	gas pressure out of range for selected method	NO
	0x0008	gas temperature out of range for selected method	NO
	0x0010	heat of combustion out of range for selected method	YES
	0x0020	relative density out of range for selected method	YES
	0x0040	molar proportion of CO2 out of range for selected method	YES
	0x0080	molar proportion of H2 out of range for selected method	YES
	0x0200	lack of solution – WirB	YES
	0x0400	lack of solution – WirC	YES
	0x1000	input data conflict	NO
	0x2000	calculated molar proportion of N2 out of range	NO
	0x4000	N2 + CO2 out of range	NO
	0x8000	conflict of result for N2	NO
	0x0000	correct calculations	NO

	0x0001	error of gas composition	YES
	0x0002	lack of solution	YES
	0x0004	gas pressure out of range for selected method	NO
	0x0008	gas temperature out of range for selected method	NO
	0x0010	heat of combustion out of range for selected method	NO
	0x0020	relative density out of range for selected method	NO
	0x0040	molar proportion of CO ₂ (carbon dioxide) out of range for selected method	NO
	0x0080	molar proportion of H ₂ (hydrogen) out of range for selected method	NO
	0x0100	molar proportion of N ₂ (nitrogen) out of range for selected method	NO
	0x0200	molar proportion CH ₄ (methane) of out of range	NO
	0x0400	molar proportion of C ₂ H ₆ (ethane) out of range	NO
	0x0800	molar proportion of C ₃ H ₈ (propane) out of range	NO
K1=const.	0x0000	correct calculations	–
	0x0004	gas pressure out of range for selected method	–
	0x0008	gas temperature out of range for selected method	–

The defined error codes are presented in hexadecimal notation. The **status alg.** value may be a bit sum of the error codes. The occurrence of a several errors at the same time is presented as a sum of the proper error codes.



For example: the errors such as:







- error of a gas composition (**0x0001**)
- error "H₂ molar proportion (hydrogen) is out of range" (**0x0080**)

The status value (concerning these two errors) will be presented as (**0x0081**).

The occurrence of the status alg. value different from the value 0x0000 causes an alarm conditions and starts the volume counting to the Vbe counter.



The screens with a technological parameters, which are not cover by the metrological control may be selected by using buttons **Λ** **V**. After this the logo of COMMON S.A.  will appear instead of the  icon in the top left corner of screen.

 CMK-03   $Q_{m,LF} = 258.84 \text{ m}^3/\text{h}$ $Q_b = 231.00 \text{ m}^3/\text{h}$ $dV_{bsh} = 74.08 \text{ m}^3$ $eph = 231.16 \text{ m}^3$ 2016/03/18 15:19:12	$Q_{m,LF}$ – current gas stream in the measuring conditions. The LF index means that the value determination is based on the low frequency transmitter pulses. If it will be determinate on basis of the high frequency transmitter, it will be displayed HF index. Q_b – current gas stream in the basic conditions dV_{bsh} – increase Vbs counter in the current hour eph – estimated dV_{bsh} hourly volume increase in the current hour
 CMK-03   $V_{bs} = 00000132845.258 \text{ m}^3$ $E_s = 1388817.706 \text{ kWh}$ 2016/03/18 15:29:09	V_{bs} – summary Vb and Vbe volume counter E_s – summary E and Ee counter of the combustion energy

	<p>inputs INx – current status of the inputs 1 – 6 (contact / NAMUR)</p> <p>outputs OUTx – current status of the double-stage outputs 1, 2, 3/LF, 4/HF</p> <p>inputs LFx – current status of the pulse inputs of converter</p>
---	---

The **ENT** button is to be select to enter the main menu, from any level of the above described screens. The main menu allows for an access to farther parameters and converter functions.

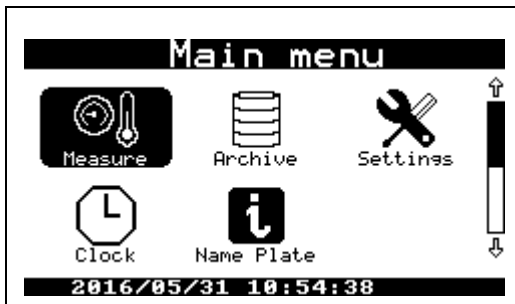
	<p>Measure – current measuring values are displayed on the several screens</p> <p>Archive – scrolling of the registered data base</p> <p>Settings – the configuration view and changing the operating parameters</p> <p>Clock – actually time and clock settings</p> <p>Name plate – converter name plate</p>
---	--

11.1.1 Menu measure



Menu contains detailed information about:

- measured values which has received from the internal and external measuring converters
- converters parameters
- converters settings

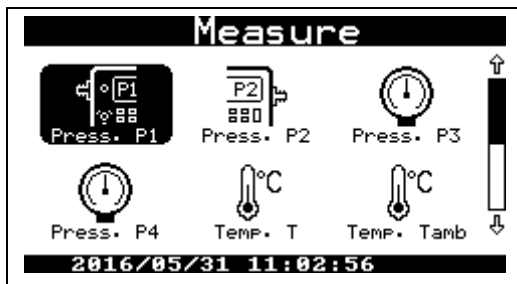
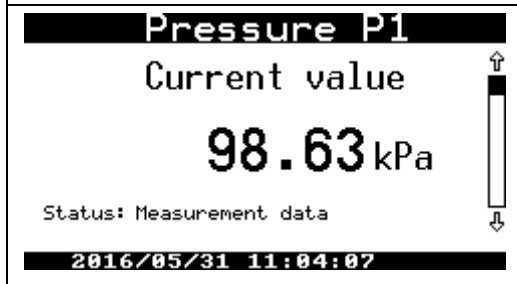
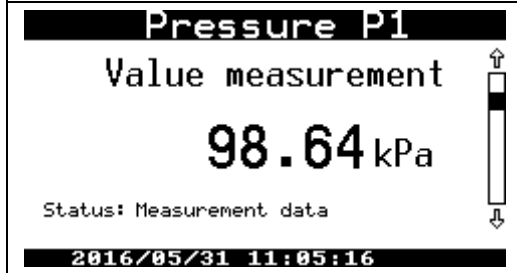
	<p>Press.P1 and Press.P2 – concern the internal pressure converters</p> <p>Press.P3 and Press.P4 – concern the additional, external pressure converters (CPC-03) which are connected to ExtCPC clamps</p> <p>Temp.T – gas temperature converter</p> <p>Temp.Tamb – housing (environment) temperature converter</p>
	<p>current p1 pressure value, used to the calculations</p>
	<p>current converter p1m pressure measured value</p>

<p>Pressure P1</p> <p>Avg. value of log</p> <p>98.64 kPa</p> <p>Status: Measurement data</p> <p>2016/05/31 11:06:23</p>	<p>average value in the registration period</p>
<p>Pressure P1</p> <p>Min/max daily value</p> <p>min: 98.57 kPa</p> <p>max: 98.67 kPa</p> <p>Status min: Measurement data Status max: Measurement data</p> <p>2016/05/31 11:06:33</p>	<p>minimum and maximum measured value in the current gas day</p>
<p>Pressure P1</p> <p>Ranges Type: Abs</p> <p>min: 90.00 kPa</p> <p>max: 600.00 kPa</p> <p>2016/05/31 11:06:52</p>	<p>converter measuring ranges</p>
<p>Pressure P1</p> <p>Limits</p> <p>min: 0.00 kPa</p> <p>max: 0.00 kPa</p> <p>2016/05/31 11:07:02</p>	<p>set alarm limits</p>
<p>Pressure P1</p> <p>Serial number</p> <p>1607004</p> <p>2016/05/31 11:07:11</p>	<p>converter serial number</p>

The menu of the others measurements looks analogical. If there is no converter e.g. P2 or P3 or P4 is inactive, it will be displayed a message "**Measurement inactive**" after entering in their menu.

The every measurement has parameters **Status**. The values and status meanings of the measuring parameters are listed below:

- "**Measurement data**" → correct result of the measurement
- "**Range overflow – process alarm**" → over crossed converter measuring ranges; but there is numerical measurement result; type: processing alarm
- "**Range overflow – system alarm**" → over crossed converter measuring ranges, or the converter is damaged, there is no measuring result; type: system alarm
- "**Constant of algorithm**" → if there is activation of the substitute value

There is displayed also a field "**Info**" (below of the field "**Status**").

The "**Info**" can receive a values and meanings as follows:

- "**Communication error with the converter**" → in case of the temporary communication error

- “Limit overflow”

→ overflow of the set measuring limits

11.1.2 Menu Archive



Menu contains the all values registered in the converter memory.

Archive	
	<p>Periodical – data registered according to the set period of time (default 10 minutes)</p> <p>Daily – data registered at the end of every gas day (default set at 6:00 a.m.)</p> <p>Events – events list and alarms which have been registered by the converter</p> <p>MID alarms – events list and alarms which have affect on the accounting-measuring parameters (MID)</p> <p>MID regist –register of interferences and a recording of changes in the configuration of the parameters</p>
<p>2016/05/31 11:11:17</p>	

The operating rule and alarms acknowledgment are described in the part: **MID alarms** and **MID interferences (configuration changes)**.



The **Periodic** menu:

Periodic registr.	
<p>Records: 12</p> <p>Last index: 11</p> <p>↑ – The oldest data</p> <p>↓ – The youngest data</p> <p>ENT- step scroll x10</p>	<p>Records – records quantity stored in the counter memory</p> <p>Last index – unique index of the last record. If the converter memory is full the number of records will stop to increase (it will be oscillate near maximum value) and the last index will be increment further.</p> <p>▲ – the oldest data</p> <p>▼ – the youngest data</p>

The selection of the ▲ or ▼ button causes the data base display appropriate from the oldest or from the newest saved data. Data may be scrolled one by one (default set). The pushing **ENT** button during the scrolling, will switch step of scrolling between 1, 10, 100 e.t.c. It is marked with “v” sign above the record digit. This informs which digit is actually scrolled from the number of records.

The selection of the ◀ or ▶ causes the switching between parameters registered in record. There is a line below where are presented the DP Table description and DP Table parameter number of the Gaz-Modem 2/3 protocol.

Periodic registr.	Periodic registr.
<p>Record: 00012 ↑↓ 11:10:00</p> <p>Index: 11 31/05/2016</p> <p>← U_m U_b U_{be} E E_e dU_m dU_b dE →</p> <p><small>GAS VOLUME COUNTER IN ACTUAL MEASUREMENT CONDITIONS</small></p> <p>DP(159): U_m</p> <p>Status: OK</p> <p style="font-size: 2em;">0.01 m³</p> <p>Status rec.: OK</p>	<p>Record: 00012 ↑↓ 11:10:00</p> <p>Index: 11 31/05/2016</p> <p>← U_m U_b U_{be} E E_e dU_m dU_b dE →</p> <p><small>UB INCREASE IN REGISTRATION PERIOD</small></p> <p>DP(239): dU_b</p> <p>Status: OK</p> <p style="font-size: 2em;">0.000 m³</p> <p>Status rec.: OK</p>



The browsing of the “Daily” menu is based on the same rule as a browsing of the “Periodical”

menu.

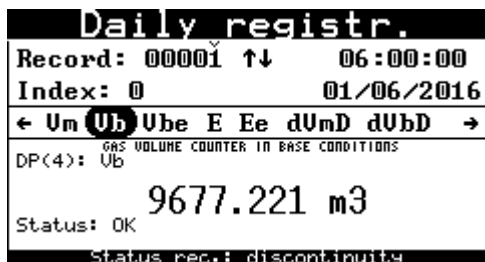

Events, MID alarms, MID register

According to the requirement of the MID directive the CMK-03 has two additional data base registers: **MID alarms** and **MID regist. (register of MID interferences)**. The functionality of these registers have been checked and metrological approved.

The MID alarms subject under control and must be read and acknowledged (confirmed). If there is no place for new MID alarms, the old alarms can be removed after acknowledgment from the converter memory.

If the base will fulfill with the unacknowledged alarms, the converter will lock a possibility of further base volume counting to the Vb counter. It will start to count to the Vbe counter, what will last until alarms reading and their acknowledgement.

The acknowledgment of the MID alarms can be done both manually and via telemetric connection by means of respectively function of the Gaz-Modem 3 protocol. The manual acknowledgment can be done from the menu level: Archive → MID alarms. Details are described in part 9.2 and in text below.

The MID register is a type of configuration changes register for accounting parameters. The acknowledgment is not required.

The **Events** register contains an all information from the **MID alarms** and the **MID register**. There is also information about additional alarms, technological events, functional events, which are available locally and remotely via Gaz-Modem 2/3 protocol.



The browsing of the Events and alarms data menu.

<p>Events Records: 9 Last index: 8 ↑ - The oldest data ↓ - The youngest data ENT- step scroll x10</p>	<p>after selection of Events menu, the first displayed information is an amount of events in the counter, the selection ↓ or ↑ causes a display of the youngest or the oldest saved event.</p>
<p>Events Record: 00009 ↑↓ 10:04:19 Index: 8 31/05/2016 (55)-OPTO-GAZ active ← p1 t t amb Um Ub E StateIN → <small>GAS TEMPERATURE</small> DP(1) 27.97 °C Status: OK Status rec.: OK</p>	<p>the buttons ↓ ↑ are used to switching between another events, the ENT button changes step of switching, the buttons ← → display another parameters which are saved in the record.</p>

<p>Events Record: 00008 ↑↓ 11:29:21 Index: 7 24/06/2016 (30)-Value modification ←(User) NrPar last v1 → <small>USER NUMBER WHO RECENTLY MODIFIED THE PARAMETERS</small> DP(79) USER-000 Status: OK Status rec.: OK</p>	<p>There is an saved information about the user who has made the changes.</p>
<p>Events Record: 00009 ↑↓ 10:04:19 Index: 8 31/05/2016 (55)-OPTO-GAZ active ←(p1) t tamb Um Ub E StateIN → <small>PI GAS PRESSURE</small> DP(0) 98.65 kPa Status: OK Status rec.: OK</p>	<p>There is an example of event which is no MID type: the status change of the signaling input. The event is “on going” what is marked with icon in position of the event ending time.</p>
<p>Events Record: 00008 ↑↓ 09:20:48 Index: 7 31/05/2016 (55)-OPTO-GAZ active ←(p1) t tamb Um Ub E StateIN → <small>PI GAS PRESSURE</small> DP(0) 98.63 kPa Status: OK Status rec.: OK</p>	<p>There is an example of event which is already ended. It occurs information about time of event ending, index has not been changed.</p>



The browsing of the MID alarms data base



menu dedicated to the alarms base browsing — it works similar to the events browsing





menu dedicated to the alarms acknowledgment

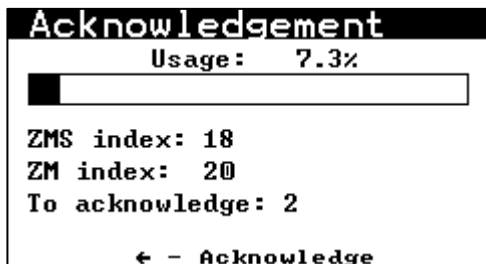

menu dedicated to the active alarms browsing

If there is at least one unconfirmed alarm in the converter, it is signaled by flashing icon on the top bar of the screen. If the menu **Acknowled** will be selected, it will display:



The selection of the  button causes a MID alarm confirmation. The acknowledgment can be done only by authorized user. The description of the log in procedure is contained in part 11.2.2. After the successfully acknowledgment it will be displayed screen with a confirmation message as below:

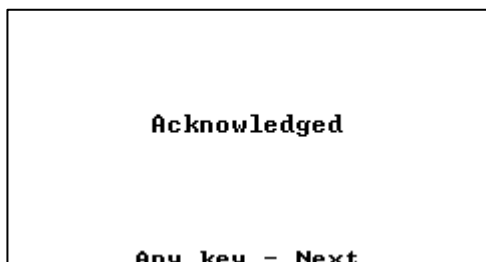

There is the interference register of the accounting parameters. The register contains information about the user, who has made modification and about recorded parameters after changing.

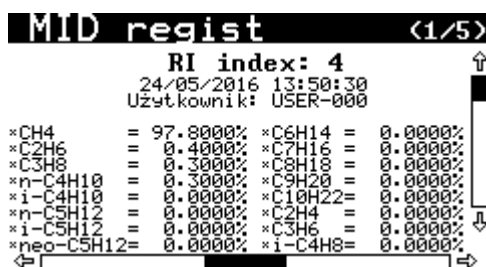
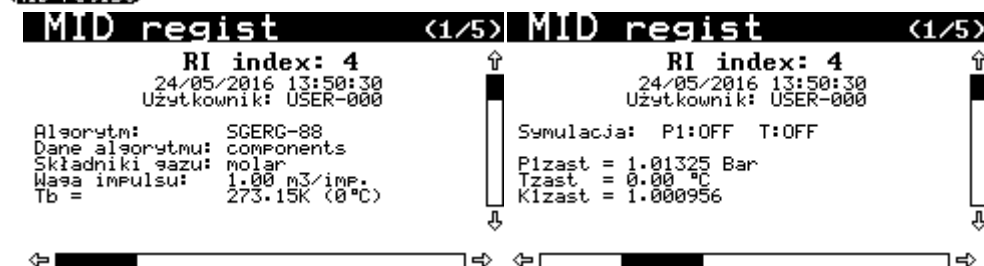

11.1.3 Menu Clock



Menu clock contains two screens which display: actually time, data with day of the week and dates of the time changes (summer / winter).

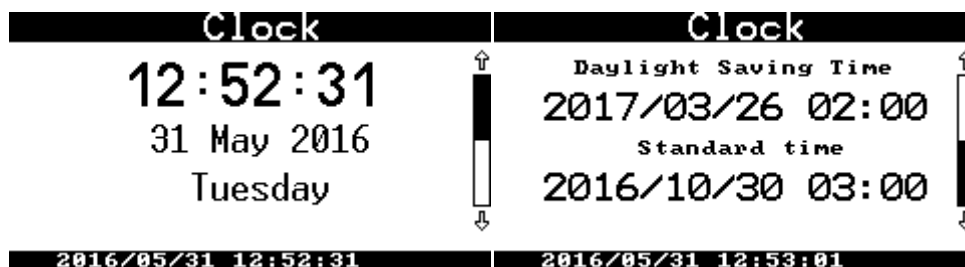

If the option of the time “auto change” (summer / winter) is disabled, it will be not displayed the date which informs about time changing. It will be displayed a message “Auto.change: NO”

The RTC clock and internal calendar is very precise. Typical error does not exceed 5 ppm, what means that is smaller than 0,5 s / 24h. It assures stable operation and there is not necessary to synchronize time in the device. The data, which are registered in many devices are correlated between each other.

11.1.4 Menu Name plate



Menu name plate contains 3 screens with information about: serial number, firmware version and manufacturer information.

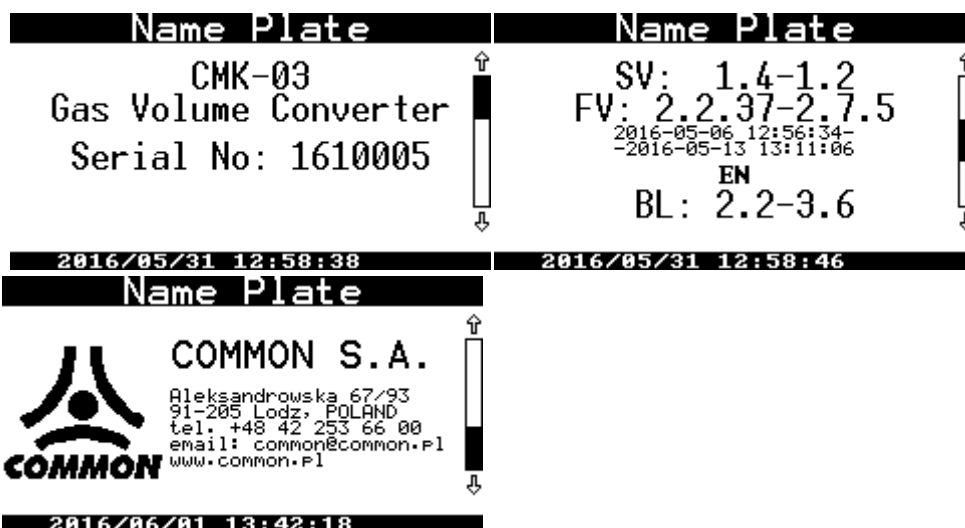

11.2 Menu Settings



11.2.1 Configuration after installation

The device requires a configuration of basic operating parameters such as:

- **Vm** counter status, according to the indication of the gas meter index head
- to record the **Vb** counter status in the protocol (not modifiable)
- **LF** pulses value
- the **gas meter constant**, if it will be used **HF** input for stream determination
- **gas composition** (to configure based on the parameters or on fully gas composition. It depends from selected calculating method)
- the calculation **algorithm** of the compressibility coefficient (SGERG-88, AGA8-92DC, K1=const)
- to control **date / time** and automatic time changing mode
- **the registration period** and start of the **gas day**
- **users**: their passwords and permissions

- to control and **acknowledge** current **MID alarms**
- **transmission parameters** on the COM1/OPTO-GAZ, COM2 or COM3 ports

Additionally can be configured:

- the name of a gas point or a gas station
- the ranges and limits of the Qm / Qb streams and other measuring parameters
- the LCD format of displayed data — it depends on the ranges of applied converters

The converter manual configuration can be done in menu: “Settings”. There are all functions collected on two screens which are dedicated to set the operating parameters.

	<p>COM ports – transmission parameters</p> <p>Logs – registration period and start of the gas day</p> <p>Gas meter – gas meter parameters</p> <p>Measure –measuring converters configuration</p> <p>Limits – limits of the measuring figures</p> <p>Gas – the gas composition and gas parameters</p>
	<p>Simulation – alternative values of the measuring figures</p> <p>Outputs – double-states outputs</p> <p>Inputs – double-states inputs</p> <p>LCD – activity time, display contrast, units of the displayed figures</p> <p>Clock – current data / time, time change summer / winter</p>

The parameters entering method is common for all of the entered figures. The method has been described in this instruction on the basis of configuration for serial ports parameters.

11.2.2 Parameters setting – general information

The entered parameters may be shared on two basic types:

- type list — where is possible to select one of the available options
- the parameter type number, where can be set a numerical value.

The type list parameter can be only a selection from the list of the available options such as ON/OFF, YES/NO, or baud rate. It is set by using **▲ ▼** buttons, which scroll the list and should be confirmed with **ENT** button.

The type number parameter is an integer or a real number with defined range (e.g. the Gaz-Modem address or Vm counter). In this case an every digit is set (scrolled) by using **▲ ▼** buttons, sometimes with decimal point. The another digit is selected to the edition by using **◀ ▶** buttons. This buttons move a cursor on the position of next digit. The entire number is set by means of this method, and it should be confirmed with **ENT** button.

The entered modification can be canceled in every moment by using **ESC** button.

The converter parameters are grouped according to the menu structure. If there is a changing only in one of the parameters, this parameter is marked with a small star sign on the left side of its name. The selection of **ESC** button, displays an enquiry regarding to the confirmation for entered changes.

<pre> COM2 Configuration changed Do you want to save? ESC - No ENT - Yes 2016/05/31 13:24:50 Log:0 </pre>	<p>ESC button cancels every entered changes</p> <p>ENT button confirms entered changes</p>
--	--

11.2.3 Log-in

The modification of the selected parameter requires to log in and user authorization. This is not necessary if the all parameters concerning the COM1 and OPTO-GAZ ports. There is no separated login function. The login screen is displayed, when there is no logged user:

<pre> COM2 User ↑ USER-000 ↓ ↑↔ Password: ↔↓ ***** 2016/05/31 13:17:34 </pre>	
<pre> COM2 User ↑ USER-000 ↓ ↑↔ Password: ↔↓ ***0 2016/05/31 13:17:50 </pre>	<p>▲▼ buttons allow for user selection</p> <p>ENT button confirms the user selection.</p> <p>The entering of user password:</p> <p>“USER-000” has the default password “0000”.</p> <p>The password is not a number. It need to be enter the four zeros.</p> <p>▲▼ buttons set the value of the selected chart</p> <p>◀▶ button navigate between password charts.</p> <ul style="list-style-type: none"> ▪ ▶ button moves indicator to the next chart ▪ ◀ button occurs to go back and cancel current position <p>ENT button confirms the entered password</p>
<pre> COM2 Login error ← Confirm 2016/05/31 13:18:01 </pre>	<p>This message informs about wrong password</p> <p>◀ button causes step back to log in window.</p> <p>ESC button allows to enter the password again or cancel the operation</p>
<pre> COM2 User logged in ← Confirm 2016/05/31 13:18:19 </pre>	<p>This message informs about proper user log in procedure.</p> <p>◀ button causes the return to parameters setting.</p>

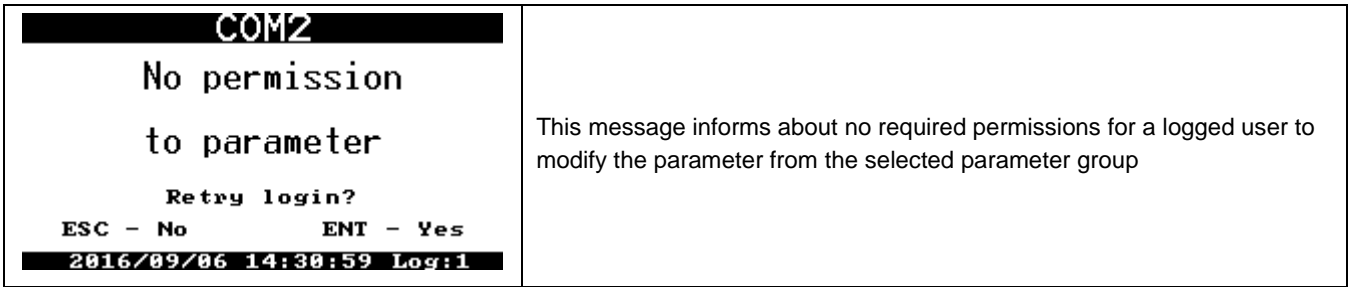

There are a few permission types which allow to modify a parameters group. The users settings and their permission level are described in the **part 0**.

The user log on time is maintained during 4 minutes when it has been made by using keyboard. This time period is counted since the last pushing of any keyboard keys (except the backlight button). After 4 minutes it will occur automatically log out.

The screen is active and the backlight is maintained during the login time period.

The log out operation is required to log in for another user.

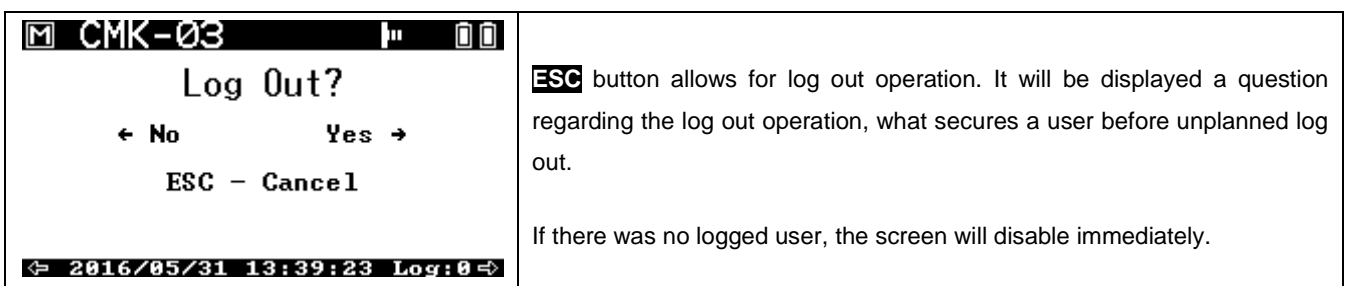

While a user is logged, there is displayed message: **Log:x**, where **x** indicate a user number: 0..3. The CMK-03 may have defined 4 users (USER-000 — USER-003). It may be assigned a different permissions levels and individual passwords for every of users. The password may contain a number from 4 till 7 digits.

The default password of USER-000 is set as four zeros: 0000.

It is recommended to change the default password to avoid unauthorized access to converter configuration!



11.2.4 Settings of COM ports

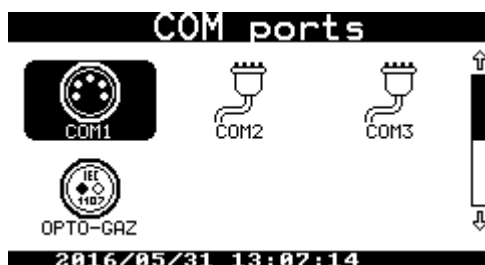

The menu COM ports allows to set as follows:

- the physical COM ports parameters
- MODBUS addresses
- GazModem3 protocols addresses.

The CMK-03 is hardware equipped in three serial ports. The COM1 and OPTO-GAZ ports share one physical serial COM1 port, but have possibility for an independent configuration of the transmission parameters. The placement of the OPTO-GAZ head will deactivate the COM1 port.

The COM1 port is located on the converters housing (TUCHEL socket) and COM2 and COM3 ports are located on the internal terminal strips.

The COM1 and OPTO-GAZ ports parameters may be modified without authorization but the parameters of the COM2 and COM3 ports after logging. The parameters setting looks the same for every port. If there is selected the menu: **Settings** → **COM ports** → **COM1** it can be seen the COM1 port setting, which are displayed on two screens.

Please notice that the default setting are marked with bolded letters in the further, below description.

	<p>The physical parameters with the settings recommended for the telemetric:</p> <p>Baud rate can be selected from list: 300, 600, 1200, 2400, 4800, 9600, 19200, 38400, 57600, 115200 bits/s.</p> <p>Parity: NONE, EVEN, ODD</p> <p>Data bits: 8, 7</p> <p>Stop bits: 1, 2</p>
	<p>GM address: the GazModem protocol address is a number from the range 1..65534 (default setting depends from the serial number and the port number)</p> <p>MODBUS addr.: the MODBUS RTU protocol address is a natural number from the range 0..247(default 1).</p> <p>MODBUS conf.: option with submenu to configure the sequence of the sent bytes.</p>

The baud rate is selected from the list by using **▲▼** buttons. The digits of the GM address are set and selected to the edition by using **▲▼** and **◀▶** buttons.

It need to be selected **ENT** button to change the parameter. After this the parameter value will be displayed in a negative-view as selected to the edition.

	<p>▲▼ buttons switch a parameter</p> <p>ENT button causes a parameter selection and an edition</p> <p>▲▼ buttons allow for selection of the required value (when the parameter is being edited)</p> <p>ENT button confirms the entered value</p>
	<p>button confirms the set value and returns to the parameters list.</p> <p>buttons select another parameter to modification</p> <p>* symbol is located on the left side of the modified parameter → value has been changed but is still unsaved</p>
	<p>GM address and MODBUS address:</p> <ul style="list-style-type: none"> ▪ ▲▼ buttons set the individual digits value ▪ ◀▶ buttons switch between digits. <p>ENT button confirms the entire set address</p>

COM2 Configuration changed Do you want to save? ESC - No ENT - Yes 2016/05/31 13:24:50 Log:0	<p>ESC button ends the parameter configuration and occurs the screen displaying with question regarding the changes saving.</p> <ul style="list-style-type: none"> ▪ ESC button cancels the all entered changes ▪ ENT button confirms and saves changes.
--	---

MODBUS config. – this function is using to configure a sequence of sent register bytes. Some drivers or systems can expect a another sequence and it can cause problems with configuration. The proper sequence should be selected in experimental way. The simplest way is to read the MODBUS Table from the register with constant, known value (e.g. pressure) and to find a correct combination.

COM2 Configuration Swap DWORD: No Swap WORD: No Swap BYTE: No 8-7-6-5-4-3-2-1 2016/05/31 13:11:54	<p>Swap DWORD – swap places of double words</p> <p>Swap WORD – swap places of double-bytes words</p> <p>Swap BYTE – swap places of bytes.</p> <p>The parameter may accept values YES or NO. The proper settings combination allows to find any sequence, which is presented in the last line during the setting time:</p> <p>8-7-6-5-4-3-2-1 (default setting)</p>
---	---

11.2.5 Registration



Menu contains a setting combined with the data base:

Logs Parameters Log period: 10 min Gas day: 6 2016/05/31 13:53:29	<p>Log period – the log period of periodically data base. The value is an integer divider of the number 60, so that assure that always one probe is related to full clock-hour. The values may be selected from the list: 1, 2, 3, 4, 5, 6, 10 (default setting), 12, 15, 20, 30, 60 minutes.</p> <p>Gas day – an hour of the gas day change. There are an integer values from the range 0...23. Default set on value 6.</p>
--	--

11.2.6 Gas meter



The menu contains all of parameters which are combined with the gas meter operating with the volume converter.

Gas meter Parameters Vm: 0000000000.01 m3 iLF: 1.00 m3/imp iHF: 2499.8846 imp/m3 Qm source:LF 2016/05/31 13:57:11	<p>Vm – the gas volume counter in the measuring conditions. It should be set on the value which is accordant to the gas meter index</p> <p>iLF – LF pulses value from the gas meter. Value can be selected from the list: 0.01, 0,1., 1.0 (default set), 10.3 m3/imp</p> <p>iHF – the gas meter HF constant ; the real value expressed in imp/m3</p> <p>Source Qm – the calculation signal source of the temporary gas stream. It is possible to select from two options: LF (default set) and HF/LF (automatic mode)</p>
--	--

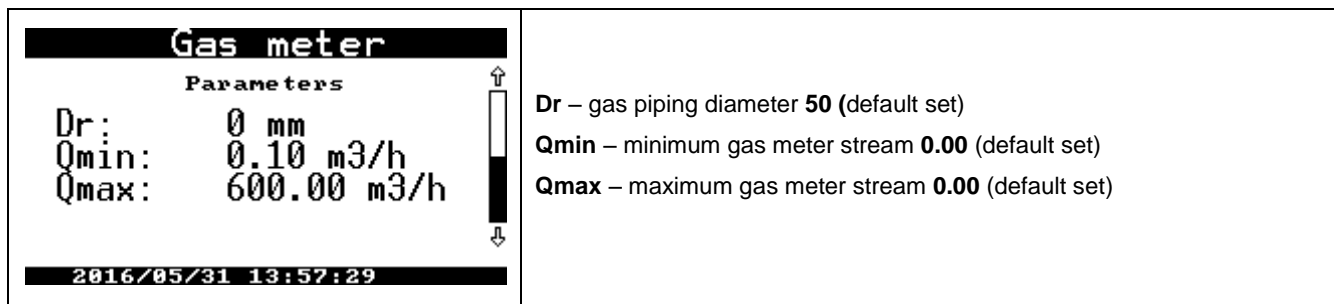

Dr – gas piping diameter **50** (default set)
Qmin – minimum gas meter stream **0.00** (default set)
Qmax – maximum gas meter stream **0.00** (default set)

LF pulses value – this value is permanent written on the name plate of gas meter. The value is expressed in a cubic meters per pulse, sometimes it is presented as pulses per cubic meter.

HF coefficient – is entered if the gas meter is equipped in a HF transmitter. The coefficient value should be permanent written on the gas meter. The value is expressed in pulses per cubic meter. The correctly programmed coefficient value is necessary for the proper **Qm_(HF)** stream determination and to control the error limit of the gas meter HF constant. It is necessary to remember about supply for the NAMUR circuits and the converter external power supply (properly clamps **+8V** and **+V** on terminal strip COM3) to assure proper work of the HF input and the HF transmitter.

The **necessary conditions** to measure the **temporary gas stream** based on the **HF signal** are listed below:

- signal source of the Qm stream should be set on HF/LF options (automatic mode)
- HF transmitter should be correctly connected
- proper power supply for NAMUR circuits on the clamp **+8V** and **+V**
- proper external power supply to the converter clamps **+V** and **GND**

If the one of the above conditions will be missing, the gas stream will be automatically calculated on the LF pulses basis.

The **Qm min** and **Qm max** parameters correspond with the gas meter measuring range. If the ranges will be set on zero ("0.00"), it will be disabled the registration functionality of the technological alarms regarding to the ranges overflows.

11.2.7 Measure



The menu contains settings of additional pressure converters. The CMK-03 standard execution has one measuring track of the gas temperature (**t**) and the gas pressure (**p1**). There are internal or external converters, which are permanent connected via cable with the CMK-03. These converters are set in their production process and are not configurable due to their accounting character.

The CMK-03 may be additionally equipped as follows:

- internal **P2** pressure converter.
- up to 2 external CPC-03 pressure converters as the **P3** and **P4** measurements.

The measurements time periods of the gas temperature (**t**) and pressure (**p**) depends from the power supply mode:

- **battery**
The measurements are executed every 30 seconds, according to the configured reading interval time period — 'RdCpCnt' parameter in the DP Table.
- **external power supply**
The measurements are executed every 1 seconds, according to the configured reading interval time period — 'RdCpAux' parameter in the DP Table

If there are used the gauge pressure converters it may be entered the offset for the pressure value. The unloaded converter, should indicate a zero (0) value. If the indication is a little different from zero by an atmospheric pressure, it is possible to **reset the converter** – the offset entering. The offset entering can be done manually or automatically.

Menu Measure:

<pre> Measure Configuration Measure P2 Measure P3 Measure P4 Meas. period Komunikacja P3, P4 - 38400 8N1 2016/05/31 13:59:36 </pre>	<p>Measure P2 – configuration of P2 converter</p> <p>Measure P3 – configuration of P3 converter</p> <p>Measure P4 – configuration of P4 converter</p> <p>Meas. period – setting of the reading time periods for an external pressure converters</p> <p>Communication P3, P4: information about physical transmission parameters for ExtCPC port and connected to it CPC-03 converters.</p>
<pre> Press. P2 Parameters Reset: Perform Act. offset: +0000.050 Current value: 0.000 kPa 2016/09/06 14:45:35 Log:0 </pre>	<p>The relative converter (gauge) has available functions:</p> <p>Reset – there are two options:</p> <ul style="list-style-type: none"> ▪ Execute — the function reads current pressure value and set it as actual offset. ▪ Cancel — the function removes offset. <p>ESC button confirms changes after offset setting.</p> <p>Actual offset – manually offset setting.</p> <p>Current value – information about converter current value</p> <p>In case of the absolute converter (abs) is displayed message and the reset options are not available.</p>
<pre> Press. P3 Parameters Active: No GM Address: 20005 Reset: Perform Act. offset: +000000.0 Current value: -nan kPa 2016/05/31 14:01:01 </pre>	<p>Press.P3 and Press.P4 menu are analogical to the Press.P2 menu.</p> <p>Active – NO/YES – the function activates the ExtCPC port and reads data from the external CPC-03 converters according to set time period.</p> <p>GM Address – Gaz-Modem address. The default CPC-03 address is always set as five last digits of the serial number.</p> <p>Reset and Act. offset – described above</p> <p>Current value — information about current value read from the converter</p>
<pre> Meas. period Configuration Battery: 30 sec Ext. power: 1 sec 2016/06/17 13:27:19 </pre>	<p>Meas. period — menu of the reading time period. The default values:</p> <p>Battery – 30 seconds</p> <p>Ext.power – 1 second.</p>

If there is an enter to the menu **Measure P2**, **Measure P3**, **Measure P4** and there is active the absolute pressure converter, the measuring period accelerates automatically to 1 second.

The CMK-03 operates with the CPC-03 external converters with baud rate on level 38400 bits/s. The CPC-03 converters baud rate should be set on mentioned value by means of dedicated configuration program (e.g. CCTool) .

WARNING!

The proper operation between the external CPC-03 converter and the CMK-03 volume converter is possible from firmware version: CPC-03 nr v.13.11.27.08

The CPC-03 with older firmware will be not operate properly with the CMK-03



The CPC-03 firmware version is written in the converter name plate. It can be read in the Gaz-Modem 2/3 protocol or as an available parameter “wersja prog” in the DP table.

11.2.8 Limits and "gas guard" function



There is a menu of the limit settings.

The Limits are dedicated to

- overflows registration (information is recorded in the Events)
- registration of the double state outputs (OUT) activation — if such option has been previously defined.

	<p>Limits P – pressure limits setting default set on zero (0); are disabled</p> <p>Limits T – gas temperature limits. default set on zero (0), are disabled</p> <p>Limits Q – Qm and Q gas streams limits. default set on zero (0), are disabled</p> <p>Limits dVbsh and eph – counters limits of the hourly increases (to reduce the hourly consumption — “gas guard” function)</p>
	<p>dVbsh1, dVbsh1, dVbsh1</p> <p>There are 3 thresholds of the dVbsh hourly increase limit. The increase of the volume summary counter in the basic and emergency conditions from the beginning of the current clock hour.</p> <p>The limits overflow occurs a alarms recording in the eph1, eph2 data bases.</p>
	<p>It is possible to set 2 limits of the eph estimated volume hourly increase. The dVbs volume increase value estimated at the end of hour is based on the dVbsh current usage from the beginning of the hour and current Qb stream value.</p> <p>The limits overflow will occur a alarms recording in the eph1, eph2 data bases</p>
	<p>estimation time– 0min/0...10min</p> <p>Estimation time = 0 min — there is a disabled function of increase estimation in the relation to dVbsh1 limit</p> <p>“Estimation time” + “dVbsh1 limit” = “Gas guard” function</p> <p>The both functions create the “Gas guard” function with the time prediction on the set numbers of minutes. The dVbs volume increase value is estimated on base of the current dVbsh usage from the beginning of the hour and the current Qb stream value. The estimation time is set in the “estimation time” function.</p> <p>If edVbsh estimated value is greater than programmed dVbsh1 limit it will be recorded the proper alarm in the data base.</p>

To use the “gas guard” functionality as the control signal for the external automatic systems it is to be programmed selected OUT outputs. The OUT output should be activated with selected alarm, settable in the menu Outputs. The alarm list is shown below:

- [56] dVbsh1 limit exceeded
- [57] dVbsh2 limit exceeded
- [58] dVbsh3 limit exceeded
- [59] eph1 limit exceeded
- [60] eph2 limit exceeded

- [66] next dVbsh1 limit exceeded (with prediction function – an overflow will occur in “n” minutes)

The example:

<pre> Output OUT2 Configuration Enable: Yes Polarity: CLOSED Alarm: 56 Desc.: dVbsh1 limit exceeded State: Inactive(Open) 2016/09/01 15:30:38 Log:0 </pre>	<p>The OUT2 output is dependent from the prediction of the overflow alarm concern the set limit with the programmed estimation time.</p>
---	--

If the estimated increase values will start to decrease after an over crossing the limits and the values will fall down below the limits, then the alarms will be ended and the OUT output which was activated by this alarm, will be switch in the inactive state.

The “Gas guard” function works in the same way both on the battery and on external power supply.

11.2.9 Gas



The “Gas” menu is a programming functions for the gas parameters. The gas parameters are necessary to the calculation of compressibility coefficient. Menu consists of a three functions:

<pre> Gas Parameters Alg. settings Gas parameters Gas comp. 2016/05/31 14:17:46 </pre>	<p>Alg. settings – algorithm settings for the calculation of compressibility coefficient</p> <p>Gas parameters – the physical gas parameters: can be entered instead of the gas composition</p> <p>Gas comp. – percentage gas composition</p>
<pre> Alg. settings Parameters Algorithm: SGERG-88 Alg. data: components pb: 101.325 kPa Tb: 273.15K (0°C) 2016/05/31 14:18:15 </pre>	<p>Algorithm – the algorithm selection; possible settings: SGERG-88, K1=const, AGA8-92DC</p> <p>Alg. data – components/parameters: components are calculated from the percentage gas composition: based on the entered parameters:</p> <p>pb – basic pressure (1,01325 bar)</p> <p>Tb – basic temperature (0, 15, 20°C)</p>
<pre> Alg. settings Parameters T1: 298.15K (25°C) Gas comp.: molar K1 subst.: 1.000000 2016/05/31 14:19:33 </pre>	<p>T1 – reference temperature for the calculation of the heat combustion (0, 15, 20, 25°C)</p> <p>Gas comp.– molar/volume; information regarding to the entered percentage gas composition: molar or volume?</p> <p>K1 subs. – compressibility coefficient alternative value , default set on 1.0</p>
<pre> Gas parameters Parameters Hs: 00.000000 MJ/m3 d: 0.000000 mCO2: 0.000000 mH2: 0.000000 2016/05/31 14:29:20 </pre>	<p>Gas parameters:</p> <p>Hs – heat combustion</p> <p>d – density in the basic conditions</p> <p>mCO2 – molar participation of the carbon dioxide</p> <p>mH2 – molar participation of the hydrogen</p>

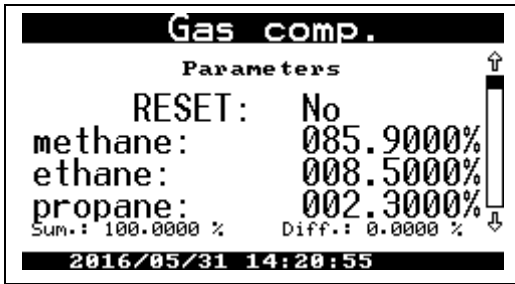
 <p>Gas comp. Parameters RESET: No methane: 085.9000% ethane: 008.5000% propane: 002.3000% Sum.: 100.0000 % Diff.: 0.0000 % 2016/05/31 14:20:55</p>	<p>The percentage gas composition settings. There is an implemented 'reset' function (two options NO/YES) which reset all of the components values. While entering there is displayed the sum of the actually entered components and their difference to 100%. The components sum has to be equal 100%.</p>
---	---

11.2.10 Simulation

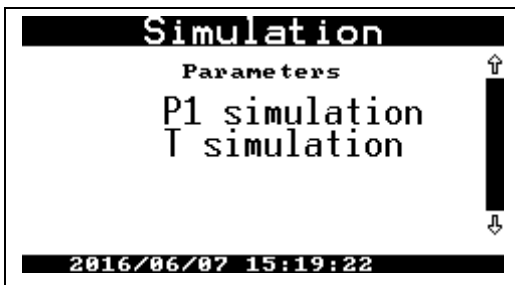
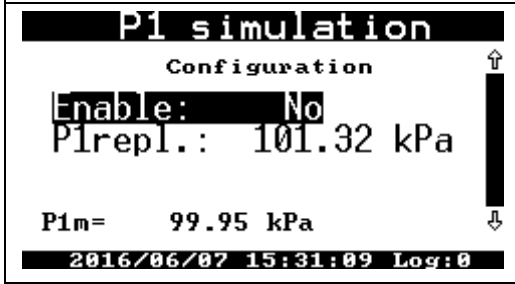
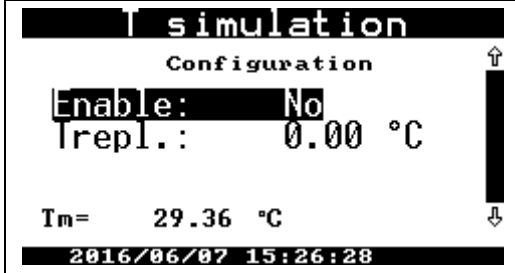

There are settings of the compressibility coefficient of **Trepl** temperature and **P1repl** pressure substitute values. The substitute values are used when there is no measurement result (states such as: measuring ranges overflows or converter damage). The calculated volume is counted to the **Vbe** emergency counter.

 <p>Simulation Parameters P1 simulation T simulation 2016/06/07 15:19:22</p>	<p>P1 simulation – P1 pressure simulation settings T simulation – T temperature simulation settings</p>
 <p>P1 simulation Configuration Enable: No P1repl.: 101.32 kPa P1m= 99.95 kPa 2016/06/07 15:31:09 Log:0</p>	<p>Enable: NO/YES — activation / deactivation of the:</p> <ul style="list-style-type: none"> ▪ pressure simulation ▪ converter operation with the P1repl substitute value <p>P1repl – P1repl. value setting P1m – the current pressure value measured by the converter.</p>
 <p>T simulation Configuration Enable: No Trepl.: 0.00 °C Tm= 29.36 °C 2016/06/07 15:26:28</p>	<p>Enable: NO/YES — activation / deactivation of the:</p> <ul style="list-style-type: none"> ▪ temperature simulation ▪ converter work with the Trepl substitute value <p>Trepl – Trepl. value setting Tm – current temperature value measured by the converter.</p>

There is possible to **activate manually the substitute values**. This functionality allows for the periodical checking the quality of temperature and pressure measurements in the converter which is in usage. The following conditions should be assure in case of the p1 pressure converter:

- to program **P1repl** pressure substitute value (e.g. value which is close to pressure value at the actual moment in the piping).
- to set **Enable: YES**. From this moment the CMK-03 will count the volume to the **Vbe** counter and the respectively alarm will be recorded in **MID alarms** and **Events** data bases.
- to connect a calibrator to the CKMT three way valve and to set a lever in the proper position what will connect p1 converter with the calibrator.
- the current pressure measured value can be observed on the screen in **P1m** position. If there is defined control pressure value it is possible to observe an indications from the pressure converter.

WARNING!

the selection of the pressure or temperature simulation on the battery working mode, causes automatically acceleration of the execution period to 1 second. This status is kept until to switch off the display backlight or until to exit from the simulation settings menu.

- the CKMT 3 way valve should be leave in the proper position after finishing of the control measurement

- the option: **Enable:** set as “**NO**” in the P1 simulation menu. The converter will return to the normal working mode with a normal measuring period.

The above method is analogical in case of the temperature control. There is possible as follows:

- to observe the indications of the temperature measurement at the moment of manually temperature set (the thermometer is placed in the calibrator, in the reference temperature field).
- to control the thermometer resistance which is placed in the reference temperature field after cables disconnection of the PT1000 (the manufactured, security seal has to be removed)
- to control the converter indications by using the calibrator/simulator of the PT1000 thermometer in the 4-cables measuring mode.

The measurement of **t** temperature or **p1** pressure is covered by the control of the metrological law. There is no possibility to adjust the converter indications in the device which is in usage. The CMK-03 is sealed with the metrological marks after the Primary Verification.



The CMK-03 converter assure an accuracy of measurements with the limiting error in the acceptable MPE range during all entire operating time.

The actions described above are only a control checking, which can be contained as a recommendation in the Manual and Maintenance Instruction of the measuring stations.

11.2.11 Inputs (IN)



There are settings of the double-state signaling inputs.

<pre> Inputs Configuration Input IN1 Input IN2 Input IN3 Input IN4 2016/05/31 14:44:14 Log:0 </pre>	<p>The converter is equipped in the 6 double-state IN inputs.</p> <p>Inputs IN1...IN4 are always Type ‘Contact’ (dedicated to the operation with “potential free” connectors Type: ‘Contact’, ‘End-contact’ or ‘Open-collector’).</p>
<pre> Inputs Configuration Inputs 5,6 Input IN5 Input IN6 2016/05/31 14:44:27 Log:0 </pre>	<p>Inputs IN5 and IN6 can be configurable as ‘Contact’ Type or ‘NAMUR’ Type</p>
<pre> Input IN1 Configuration Act. input: Yes Polarity: CLOSED Current state: Open 2016/05/31 14:45:06 Log:0 </pre>	<p>There are two configuration options for the Inputs ‘Contact’ Type</p> <p>Act. inputs – YES/NO – an activation of the input and alarm registration</p> <p>Polarity – (CLOSED / OPEN).</p> <ul style="list-style-type: none"> ‘Closed’ activates the alarm in case of input short circuit. ‘Open’ activates alarm in case of electrical opening. <p>There is presented a physically Current state of the circuit in the line below</p>
<pre> Inputs 5,6 Configuration Inputs 5,6: Contact 2016/05/31 14:45:38 Log:0 </pre>	<p>Inputs 5, 6 — there are two options of the inputs standards</p> <ul style="list-style-type: none"> CONTACT — default set NAMUR — it is necessary to provide an external power supply of the NAMUR circuits and converter power supply (clamp +8V and V+ on terminal strip COM3)

<pre> Input IN5 Configuration Act. input: Yes Polarity: CLOSED Open NAMUR: Yes Clos. NAMUR: Yes Current state: Open 2016/06/08 13:58:53 </pre>	<p>The input activation and polarity setting of the IN5 and IN6 inputs is analogical for the NAMUR operating mode as for the 'Contact' Type operating mode.</p> <p>There are two options available:</p> <p>Open NAMUR – YES / NO – the alarm is detected and registered when there is a breaking of the electrical circuit of NAMUR transmitter/input</p> <p>Clos. NAMUR – YES / NO – the alarm is detected and registered when there is a short circuit of the electrical circuits of NAMUR transmitter/input</p>
---	--

11.2.12 Outputs (OUT)



There are settings of the double-state signaling outputs.

<pre> Outputs Configuration Output OUT1 Output OUT2 Output OUT3 Output OUT4 2016/06/08 14:16:10 </pre>	<p>There are four double-state OUT outputs 'Open-collector' Type. The configuration should be started from output selection.</p> <p>There is possible as follows:</p> <ul style="list-style-type: none"> ▪ to activate the output ▪ to set the output polarity ▪ to select activation alarm ▪ to activate 'LF bypass' or 'HF bypass' function.
<pre> Output OUT1 Configuration Act. output: No Polarity: CLOSED Alarm: 0 Desc.: None State: Inactive(Open) 2016/05/31 14:37:39 </pre>	<p>Act. outputs – YES / NO; activation / deactivation of the output functionality</p> <p>Polarity – (CLOSED / OPEN) – the selection of the output polarity (if the function is active).</p> <p>"CLOSED" – the short circuit of output clamps on the moment of logical output activation (e.g. overflow of the pressure limit). Option can be used for signal negation (e.g. to cause the output open circuit if there is an overflow alarm of the set volume increase).</p> <p>Alarm – (0) alarm number which causes the output activation.</p> <p>There are presented in the lines below as follows:</p> <ul style="list-style-type: none"> ▪ Desc. — alarm description ▪ State — the current output status <p>If the selected alarm is active, the output status will be conform with polarity setting.</p>
<pre> Output OUT1 Edition Act. output: Yes Polarity: CLOSED Alarm: 0 Desc.: None State: Inactive(Open) 2016/05/31 14:42:07 Log:0 </pre>	<p>Example:</p> <ul style="list-style-type: none"> ▪ OUT1 output → enabled ▪ the polarity of activated output → closed what means normally open circuit. <p>In case of the p2 limit overflow, the OUT1 output circuit will be closed during a all time of the alarm.</p>
<pre> Output OUT3 Configuration BYPASS LF: No Enable: No Polarity: CLOSED Alarm: None Desc.: None State: Inactive(Open) 2016/06/08 15:23:11 </pre>	<p>There is a LF bypass function in the OUT3 output. If this option is active (set on: YES) the current status of LF input will be the same on the double-state OUT3 output. This signal can be used for an external automatic systems. The activation of the LF bypass function does not affect on the incoming LF signal and its counting and converter operating.</p> <p>If there LF bypass function is activated, the alarms function does not work and are unavailable on the OUT3 output.</p>

<pre> Output OUT4 Configuration BYPASS HF: No Enable: No Polarity: CLOSED Alarm: None Desc.: None State: Inactive(Open) 2016/06/08 15:23:41 </pre>	<p>There is HF bypass function in the OUT4 output. If this option is active (set on: YES) the current status of the converter HF input will be the same on the double-state OUT4 output. There is also necessary to provide the proper external power supply to the COM3 port (V+ and +8V). This signal can be used for an external automatic systems. The activation of the 'bypass' function does not affect on incoming HF signal and its measurement.</p> <p>If the HF 'bypass' function is activated, the alarms function does not work and are unavailable on the OUT4 output.</p>
--	--

11.2.13 Control of odorizing unit, OUT1 output proportional to the Vbs



The OUT1 output can generate pulses and this function can be used to control of the gas odorizing unit. The generated pulses have programmed parameters which are proportional to the **Vbs** increasing summary basic volume ($V_{bs} = V_b + V_{be}$).

<pre> Output OUT1 Configuration *Enable: Yes Polarity: CLOSED *Alarm: 2 *Vbs prop.: Yes Desc.: P2 limit exceeded State: Inactive(Open) 2016/09/01 15:33:20 Log:0 </pre>	<p>Vbs prop. – YES / NO. Menu → Settings → Outputs → OUT1</p> <p>The default setting (NO) deactivates the function. If the user want to activate the pulse output (proportional to the V_{ba} increase), the $V_{bs}.prop$ parameter need to be set on: YES.</p> <p>The changes should be saved.</p>
<pre> Output OUT1 Parameters The period of 1000 ms Weight imp. 1.00 imp Desc.: The output proport. to the Vbs 2016/09/01 15:35:41 Log:0 </pre>	<p>There will be activated 2 next parameters:</p> <p>Imp. period – 1000ms pulses will be generated with the selected period. The fullness coefficient is equal 50%. The possible selection of the period as follows: 200, 400, 600, 800, 1000, 1200, 1400, 1600, 1800, 2000ms.</p> <p>Pulse value (Weight imp.) – 1.00 m³ the value setting of the output pulse.</p> <p>The pulse will be generated with every cycle of volume increase value, which is defined on the OUT output.</p> <p>The possible range of programmed value – any number in the format XXXX.XX m³</p>

The polarity setting (CLOSED / OPEN) is available in the output configuration. The alarm settings are not important. The alarms do not interfere (even if was set) on the output status (configured as the output proportional to the V_{bs}).

If the V_{bs} increase is greater than set pulse value, it will be generated the number of pulses (type integer) on the output. This number results of the multiple pulse value contained in the V_{bs} increase value.

WARNING!

The pulse period and the pulse value of OUT1 output should be set accordingly to the real occurring basic gas streams (depending from: size of gas meter, pressure, temperature), so as the OUT1 output will be able to generate an pulses proportional to the V_{bs} , between next incoming pulses from the gas meter (the volume increases).



If the V_{bs} volume increase is faster than possibility of pulse generation, the CMK-03 will buffer on-going the information about surplus of pulses which need to be generate and develops them successively in the form of the cyclic pulses on the output. The all outstanding pulses will be generated if the stream value will decrease.

The used algorithm provides an effect of the unlimited buffer — it will be not missed any of the pulses which should be generate.

The odorizing unit control of the output which is proportional to the V_{bs} increase operates on the same rules both on battery and on external power supply. The functionality is maintained also for the LF and HF signal source of the gas meter.

11.2.14 LCD



The LCD settings such as: contrast, activity time of the display, unit format of the measured figures.

	<p>Act. time – activity time in the battery working mode</p> <p>Contrast – display contrast</p> <p>P1...P4 Unit – selection of the pressure unit. Available units: kPA, MPa, psi</p>
	<p>P1...P4 Format – format of the pressure value (the number of digits before point and after point) The unit format should present 5 or 6 significant digits of the measured value.</p>
	<p>t Unit – unit of gas temperature. Available units: °C, K, °F, °R</p> <p>tamb Unit – unit of the housing temperature. Available units: °C, K, °F, °R</p>
	<p>t Form. – format of the gas temperature value (the number of digits before point and after point)</p> <p>tamb Form. – format of the housing temperature value (the number of digits before point and after point) The unit format should present significant digits of the measured value.</p>

11.2.15 Users



The user setting menu:

- user passwords
- user permissions to modify the converter parameters

	<p>users list</p>
--	-------------------

<pre> USER-000 Configuration Password Permissions 2016/06/09 12:35:10 </pre>	<p>The “USER-000” (default) user is active with password “0000” (default). This user can not be deactivated by other user both from the local level and from the authorized level. It is impossible to disable the ‘USER’ and ‘Firmware’ permissions of the USER-000.</p>
<pre> USER-001 Configuration Active: No Password Permissions 2016/06/09 12:42:27 </pre>	<p>USER-001, USER-002, USER-003 – users are inactive (default). The first activation of them is possible from the authorization level by the USER-000.</p>
<pre> USER-001 Configuration Password: ***** Replay: ***** Password: 4 - 7 digits 2016/06/09 12:36:41 </pre>	<p>PASSWORD – password modification requires user login and double entering of the new password. The password contains 4-7 digits.</p>
<pre> USER-001 Configuration COM2: No COM3: No Clock: No User: No 2016/06/09 12:37:17 </pre>	<p>Setting of the user permissions:</p> <ul style="list-style-type: none"> COM2 – parameter connected with the transmission of COM2 port COM3 – parameter connected with transmission of COM2 port Clock – parameter connected with time, date, time changing User – users activation, changing of the password and permissions
<pre> USER-001 Configuration Firmware: No Device: No Limits: No Parameters MID: No 2016/06/09 12:37:46 </pre>	<p>Setting of user permissions:</p> <ul style="list-style-type: none"> Firmware – firmware upgrade Device – technological parameters of device Limits – limit values of alarms Parameters MID – parameters under metrological control

11.2.16 Clock



The clock menu: date, time, time auto change (summer/winter).

<pre> Clock Parameters Date: 2016.05.31 Time: 14:57 Auto. change: Yes 2016/05/31 14:57:41 </pre>	<ul style="list-style-type: none"> Data – setting of the calendar data Time – setting for current time of RTC clock Auto. change – disable / enable for automatically time switching summer/winter. Available values: YES / NO.
---	---

12. Settings of extended functionalities

The CMK-03 volume converter has extended functionalities which are used in the special issues. These functions are not presented on the display and are available in the Gaz-Modem2/3 protocol via remote access mode and also visualized in the CCTool computer program.

12.1 Summary alarms

There are two options to configure the summary alarms: **A summary alarm** and **B summary alarm**. The user can select any of available, single alarm (from the group of the permanent alarms) which is a part of summary alarm. The summary alarm will end if there will be not active any of the alarms from the selected group. During the summary alarm, the occurrence of the additional configured alarm does not cause the opening of the new summary alarm.

The summary alarms are registered as a permanent alarms in the bases: Alarms and Events. The alarms are additional possibilities for automatic and telemetric systems to monitor the gas station.

The status of summary alarm can activate the selected signaling output. The OUT outputs configuration method is available from the level of CCTool program, and is described in the part **11.2.12 OUT Outputs**.

The summary alarms configuration is based on “drag and drop” interface function in the CCTool program. The access to the configuration menu is available regarding to the path: **Configuration** → **Alarms** group → indicator of the **A summary alarm**, or **B summary alarms**.

The configuration of the summary alarms in the Gaz-Modem 2/3 protocol is based on the proper setting of DP Table parameters as a bitmap which relates to the proper product codes of the ZD Table.

The DP table parameters which are used to configure **A Summary Alarm**:

- **al_GA0** binary vector which activates summary alarm type A for alarms from 0 till 31
- **al_GA1** binary vector which activates summary alarm type A for alarms from 32 till 63
- **al_GA2** binary vector which activates summary alarm type A for alarms from 63 till 95
- **al_GA3** binary vector which activates summary alarm type A for alarms from 96 till 127

The DP table parameters which are used to configure **B Summary alarm**:

- **al_GB0** binary vector which activates summary alarm type B for alarms from 0 till 31
- **al_GB1** binary vector which activates summary alarm type B for alarms from 32 till 63
- **al_GB2** binary vector which activates summary alarm type B for alarms from 63 till 95
- **al_GB3** binary vector which activates summary alarm type B for alarms from 96 till 127

To disable the functionality of summary alarm it should be proceed as follows:

- the selected alarm should be removed from the list
- the vectors which activate specific summary alarm, should be reset on zero.

12.2 Control of error of the gas meter HF/LF constant

To enable the control functionality of the gas meter HF/LF constant error it should be:

- to equipped a gas meter in two types of transmitters LF and HF;
- to switch Qm stream source on “LF+HF” (parameter ‘Qm src’ in DP Table);
- to assure a external power supply V+ of converters, and power supply of NAMUR +8V;
- to set HF transmitters constant (the number of HF pulses relating to one cubic meter – **impHF** parameter in DP Table) read from the name plate of controlled gas meter.
- to set possible percentage error limit of the transmitter HF constant (**eHFdl** and **eHFgl** in DP Table);

The percentage error is calculated between a counted constant and the constant written on the name plate (**eHF** parameter in the DP Table) by every LF pulse.

If there is an limits overflow, it will be recorded the alarm (code 63) and displayed the message “**eHF limit exceeded**”. This alarm code can indicate for example: a gas meter damage, or a transmitter damage, or improper position of the HF transmitter, etc.

To disable the control functionality of the gas meter constant error, the value of error limits should be set on zero (0).

The availability of HF transmitter constant:

- **impHF/LF** parameter in DP Table [imp/m3].

- the CCTool program: bookmark **Configuration** → **Gas meter** → indicator **HF transmitter constant [imp/m3]**

The availability of the limits errors of HF constant:

- **eHFdl [%]** and **eHFgl [%]** parameters in the DP Table — accordingly top and bottom limit
- the CCTool program: bookmark **Configuration** → **Gas meter** → indicator **error limit of the HF constant**

12.3 Operating below Qmin of gas meter – operating range: QmSTOP ↔ QmMIN.

The configurable **QmStop** parameter describes a stream value at which the gas meter will stop.

If the current Qm stream value will be in the range between programmed values of **QmStop** and **QmMin**, the volume converter will record the permanent alarm with code 62 and display the message "**QmStop < Qm < QmMin**". If the stream value will return to the proper, operating range between QmMin and QmMax, or from zero to QmStop, the alarm will be close.

The alarm contains information as follows:

- Qm stream from the beginning of alarm;
- actual QmStop value;
- p1, t, tamb, status of the double-state Inx inputs;
- **Vmk, Vbk, Ek** counters from the beginning of alarm;
- **Vmk, Vbk, Ek** counters from the end of alarm;

The reading and analysis of this parameter provides information about date and time when the gas meter worked at the stream below bottom measuring range.

To disable a functionality of the alarm registration in the operation range QmStop ↔ QmMin, the QmStop parameter is to be set on value equal with the bottom measuring range of gas meter.

To disable a functionality of the alarm registration for the range and QmStop overflows, the limits parameters are to be set on zero ("0.00").

12.4 LCD power supply

There is possible to configure a LCD setting and LCD backlight in case of the service action, connection or disconnection of the external power supply, inactive time and energy consumption etc, what determinate the energy usage.

The settings availability in the CCTool programs: bookmark **Configuration** → **LCD**.

There are three most typical LCD operating modes:

- **DEFAULT** – LCD activation without backlight, turn off on the battery after time
- **ECONOMIC** – LCD activation without backlight, the external power supply does not turn on the LCD
- **CONFORT** – LCD activation with backlight in every power supply mode, readability and availability

There is possibility to set the LCD individually by means of the options form mentioned above modes:

- automatic LCD backlight on the battery supply
- automatic LCD backlight on the external power supply
- LCD always turned-on on the external power supply
- activate the LCD after detection of the external power supply
- automatic LCD backlight after detection of the external power supply
- deactivate LCD if there is a loss of the external power supply
- LCD activity time on the battery supply
- LCD activity time on the external power supply

12.5 Reserve1 configuration in the Gaz-Modem1

The CMK-03 operates a functions of the Gaz-Modem1 protocol where the 'rez1' position informs about the pressure value of external converter (P2, P3 or P4) in the read frame of current data. To define the number of used converter is to be set the **ConfigRez1** parameter in DP Table — possible values: 1, 2, 3.

In the CCTool program: bookmark **Configuration** → **General** → indicator **rez1 configuration in GM1**.

12.6 Activity time of OPTO-GAZ port

The OPTO-GAZ transmission port is activated automatically, after a placement of the optical head. The port is automatically deactivated after the period of inactive time (no transmission). The automatic deactivation is applied because of:

- battery saving;
- prevention against permanent blocking of the COM1 (TUCHEL) port through the OPTO-GAZ interface;

The deactivation is realized by means of the parameter:

- **OptoExpireTime [s]** — in the DP Table
- in the CCTool program: **Configuration** → **COM ports** → **OPTO-GAZ** → indicator **OPTO-GAZ activity time**.

13 Remote control of the CMK-03, Users, authorization

The CMK-03 is equipped in a four digital communication ports which assures reading as follows:

- current measured data
- registered data
- configuration data
- registered alarms and events.

The transmission is provided by the selected **Gaz-Modem 1/2/3** or **MODBUS** protocols. The modification of configuration parameters is possible by means of the **Gaz-Modem 2/3** protocol after an authorization with user ID and correct password.

The data transmission can be realized with any of program which is compatible with the selected protocol. The **Gaz-Modem 2/3** protocol is standardized and described in the Factory Standard ZN-G-4007 and in the standard ST-IGG-0207.

The **CCTool** program is dedicated to service and transmission with CMK-03. The program is provided and supported by COMMON S.A.

13.1 CCTool configurator

The CCTool is a freeware program provided by COMMON S.A. which is dedicated to configure, to data reading and to manage of the CMK-03. The program requires **Windows XP SP3 or higher version of operating system** with installed **Microsoft.NET Framework Version 2.0** and **Microsoft.NET Framework 4.0** to works correctly. Program is free to download from the web site www.common.pl.

The connection with the CMK-03 is realized as follows:

- by means of the communication ports (**COM1, COM2, COM3**) which operates in the **RS-GAZ2** standard (**intrinsically safe version** of RS-485 interface).
- by means of the optical head **COG-USB-03** manufactured by COMMON S.A (connected to the OPTO-GAZ port)

The COG-USB-03 optical head is available as additional accessories – look at the Table 2.1 Additional Accessories.

The example screenshot of the CCTool menu is presented below:

Find...	Sum	100.0000 %	Missing	0.0000 %	Reset components	C6+	0.0000 %
methane (CH4)	85.9000	%	ethane (C2H6)	8.5000	%	propane (C3H8)	2.3000
n-butane (n-C4H10)	0.3500	%	i-butane (i-C4H10)	0.3500	%	n-pentane (n-C5H12)	0.0500
n-pentane (n-C5H12)	0.0500	%	neo-pentane (neo-C5H...	0.0000	%	n-hexane (C6H14)	0.0000
n-heptane (C7H16)	0.0000	%	n-octane (C8H18)	0.0000	%	n-nonane (C9H20)	0.0000
n-decane (C10H22)	0.0000	%	ethylene (C2H4)	0.0000	%	propane (C3H6)	0.0000
i-butene (i-C4H8)	0.0000	%	cis-2-butene (cisC4H8)	0.0000	%	isobutene (C4H8)	0.0000
1,2-butadiene (1-2C4H6)	0.0000	%	1,3-butadiene (1-3C4H6)	0.0000	%	1-pentene (1-C5H10)	0.0000
cyclopentane (C5H10)	0.0000	%	benzene (C6H6)	0.0000	%	toluene (C7H8)	0.0000
methanol (CH3OH)	0.0000	%	hydrogen (H2)	0.0000	%	water vapor (H2O)	0.0000
hydrogen sulphide (H2S)	0.0000	%	carbon monoxide (CO)	0.0000	%	helium (He)	0.0000
neon (Ne)	0.0000	%	argon (Ar)	0.0000	%	nitrogen (N2)	1.0000
oxygen (O2)	0.0000	%	carbon dioxide (CO2)	1.5000	%	sulphur dioxide (SO2)	0.0000
air (AIR)	0.0000	%					

The CCTool program assure as follows:

- communications by using selected transmission channel: serial port, Internet , modem
- parameters and proprieties presentation
- configuration of all parameters used to configure the CMK-03
- diagnostic and alarms reading
- current data reading
- registered data reading
- updates for internal firmware of the device

The CCTool program has a option which automatically update the system version. Updates are checked and downloaded via Internet from the server of Common S.A. Company.

The detailed information about the CCTool are described in menu: **Program \ Help** and also on website www.common.pl

13.1.1 Connection by using COGUSB-03 interface

The **COGUSB-03** optical interface assures connection between PC computer and the CMK-03, which is located in the explosion hazard area.

The data exchange between read device and **COGUSB-03** optical head is realized via IR radiation. The optical head should be placed on OPTO-GAZ port of the read device by using built-in permanent magnet. The USB terminal is connected to the PC computer and work as **1.1** or **2.0** standard.

The optical head and the holding place are presented in Figure 12.1. The COGUSB-03 is available as an additional accessory – see Table 2.1.

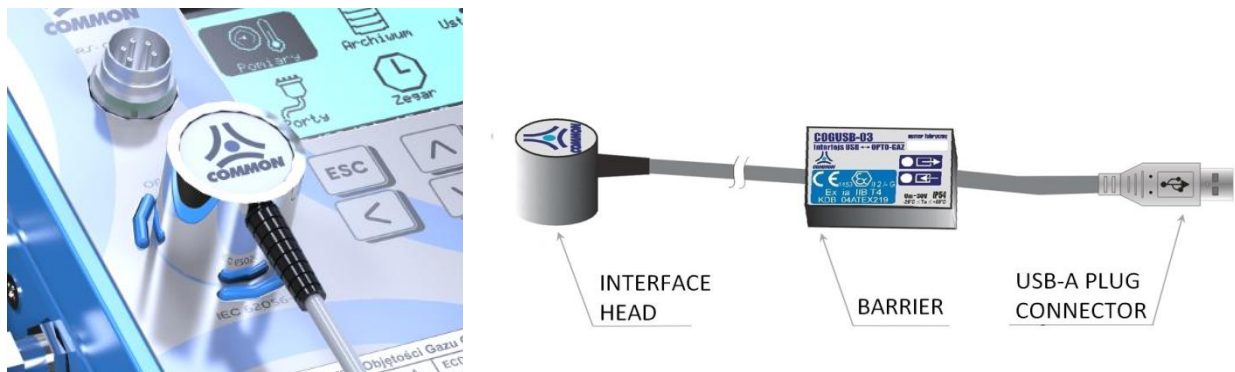



Figure 13.1 The placement of the OPTO-GAZ optical head

The external power supply is not required if the data transmission is realized by means of the OPTO-GAZ. The reading is possible both on the battery and on the external power supply working mode.

The OPTO-GAZ port is automatically active at the moment of optical head placement. The connection is confirmed with flashing  icon, which is visual on the top bar of LCD main screen.

The port is active during a transmission time. If there is no transmission, the port remains active according to the defined time in the time period option ('OPTO-GAZ activity time' parameter). The parameter is default set on 600 seconds.

The usage of the OPTO-GAZ port blocks transmission on the COM1 (TUCHEL) port during activity time what is indicated with flashing  icon on the LCD.



The reading and configuration can be realized by means as follows:

- to connect interface to the **USB** port of **PC** computer
- to install the COGUSB-03 drivers (available on the website: www.common.pl)
- to start the **CCTool** program (available on website: www.common.pl)
- to select **COM port** from ports list, with description **COGUSB-04<->OPTO-GAZ** (the same as in Figure below).
- to select the baud rate according to the **OPTO-GAZ** port settings (menu: **Settings**→ **COM ports**→**OPTO-GAZ** on the converter display).

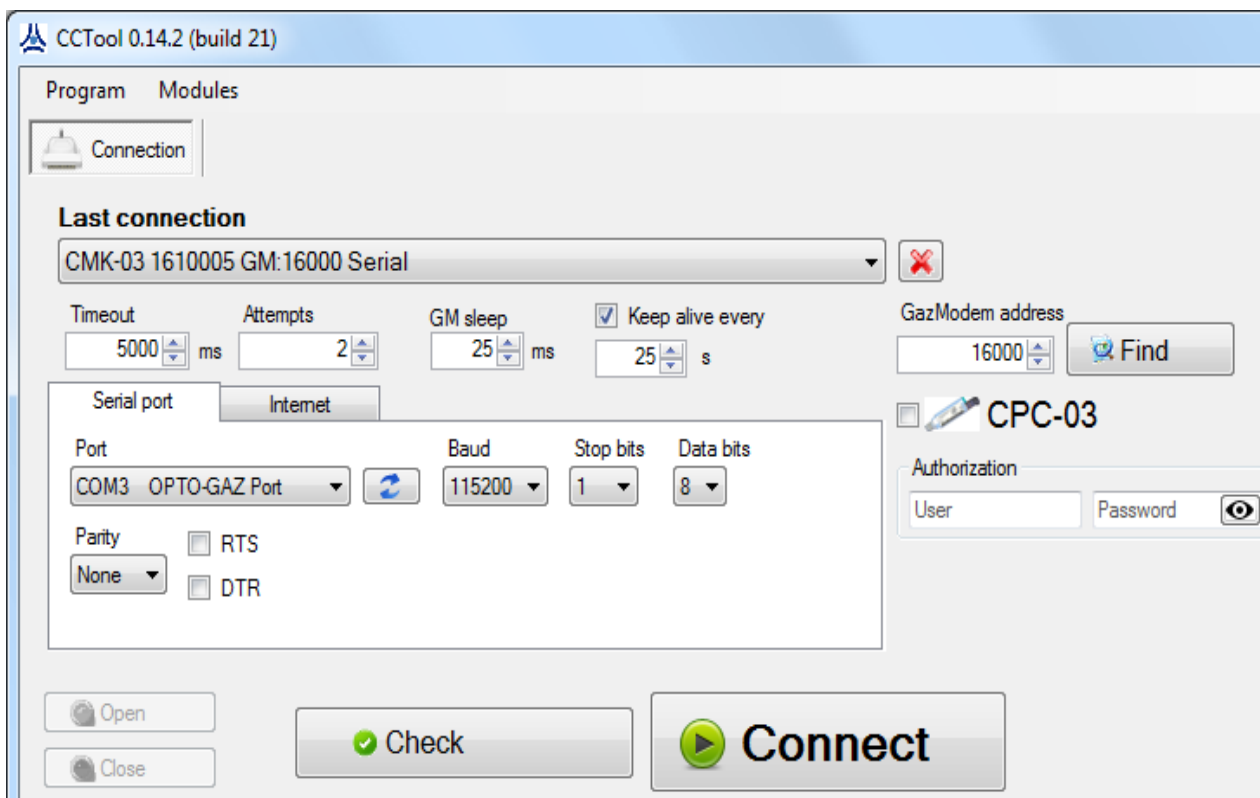

- to select option/button '**Connect**'

13.1.2 Users and authorization

The "User 0" account is default active in the CMK-03 (user ID:"**USER-000**", password: "**0000**"). The permission level of the "User 0", allows for the modification all group of the parameters (COM ports, clock, users permissions, firmware, device manage, settings for limits and MID parameters).

If the CMK-03 is ready to work, the owner / installer is obligated to change the default password responsible for the authorization, acknowledgment and parameter modification.



The “**User-000**” can activate next user and set his password and level of permission. The identifiers (ID) for new activated users: **USER-001**, **USER-002** **USER-003** are not modifiable. The password can be the numbers with length from 4 till 7 digits.

The example of the CCTool screenshot with configuration of the user account is presented below:

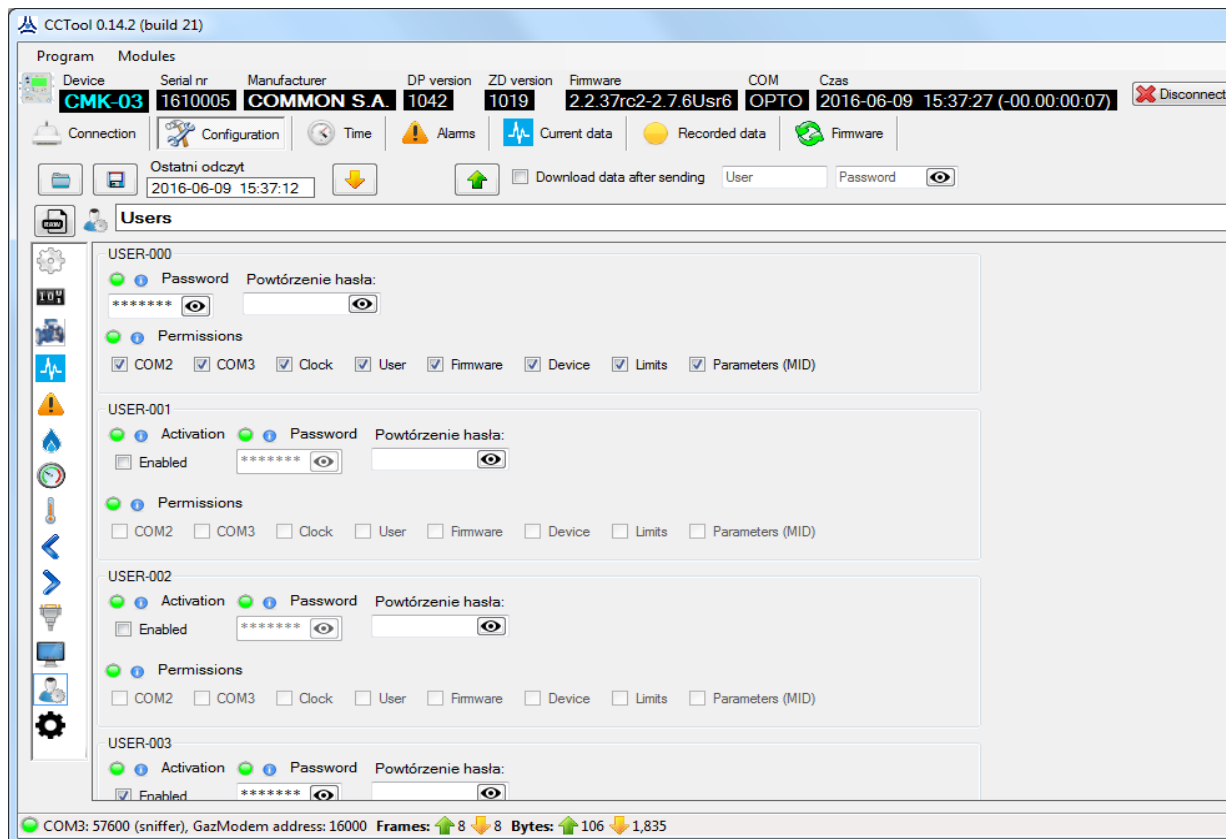

The authorization is realized from local service level, after ID selection and the password entering (see part 11.2.3). The modification of user accounts from LCD menu level is described in the **part 11.2.14**.

14 Data registration, reading and configuration in the telemetric systems

The **CMK-03** controls **348 gas parameters**. Data are classified as follows:

<ul style="list-style-type: none"> ▪ to read ▪ to modification ▪ to registration with a registration period 	<ul style="list-style-type: none"> ▪ daily registered data ▪ MID alarms ▪ Events
--	---

The all types of data are directly available in device menu (see **part 11 – Local service**).

There is possible to read and register the data via a telemetric systems by means of **Gaz-Modem 1/2/3** protocol. The current data can be read by means of the **Gaz-Modem1/2/3** or **Modbus RTU** protocols.

The parameters modification and reading of registered data is possible by means of the dedicated **CCTool** configuration program or other program which is able to read the **GMWin** (see **part 12 Remote control of the CMK-03 converter, users, authorization**).

14.1 Registered data

The **CMK-03** volume converter has 3 type of the registered data:

- registered data with the registration period (1; 2; 3; 4; 5; 6; 10; 12; 15; 20; 30; 60) min
- daily registered data
- Events and MID alarms (the details are described in the **part 9 MID alarms** and **part 10 MID interferences (configuration changes)**).

14.1.1 Data registered with registration period and daily registered data

The registered data with the registration period (1; 2; 3; 4; 5; 6; 10; 12; 15; 20; 30; 60) are recorded in the internal non-volatile, rotary memory. The capacity of base is prepared for 30 000 of records.

The registration period is available as the “**Regist Period**” option in LCD menu, and as the **dtau** parameter in the **DP Table**. If the registration period is set on **10 minutes**, the oldest data will be overwrite after **167 days**.

The daily registered data are recorded in the non-volatile, rotary data base. The base capacity is calculated on the 2200 days (6 years).

WARNING:

The beginning of the gas day is defined as the ‘gas day’ parameter in the CMK-03 menu or as the ‘HD’ parameter in the DP Table.

The reading of the registered data is possible locally from the menu (see **part 11.1.2**) or by means of **Gaz-Modem 1/2/3** protocols via one of three communication **COM (RS-GAZ2)** ports or one **OPTO-GAZ** port.

The list of the registered parameters in presented in the **Table 14.1**.

Table 14.1 List of the DP parameters

LP	number in DP table Gaz- Modem protocol	name	Description	Data format	Parameter registered with Regis- tration period	daily registered param- eter
1	0	p1	Gas pressure p1	short real	✓	
2	1	t	Gas temperature	short real	✓	
3	4	Vb	Volume counter in basic conditions	uint64	✓	✓
4	5	Vbe	Volume counter in basic conditions In emergency state	uint64	✓	✓
5	10	Vbs	Summary counter Vb+Vbe	uint64	✓	✓
6	11	p2	Gas pressure p2	short real	✓	
7	12	p3	Gas pressure p3	short real	✓	
8	13	p4	Gas pressure p4	short real	✓	
9	15	p1peakMin	Minimum p1 value in registration period	short real	✓	
10	16	p1peakMax	Maximum 1 value in registration period	short real	✓	
11	17	p1MinD	Minimum p1 value in gas day	short real		✓
12	18	p1MaxD	Maximum p1 value in gas day	short real		✓
13	20	p2peakMin	Minimum p2 value in registration period	short real	✓	
14	21	p2peakMax	Maximum p2 value in registration period	short real	✓	
15	22	p2MinD	Minimum p2 value in gas day	short real		✓
16	23	p2MaxD	Maximum p2 value in gas day	short real		✓
17	25	p3peakMin	Minimum p3 value in registration period	short real	✓	
18	26	p3peakMax	Maximum p3 value in registration period	short real	✓	
19	27	p3MinD	Minimum p3 value in gas day	short real		✓
20	28	p3MaxD	Maximum p3 value in gas day	short real		✓
21	30	p4peakMin	Minimum p4 value in registration period	short real	✓	
22	31	p4peakMax	Maximum p4 value in registration period	short real	✓	
23	32	p4MinD	Minimum p4 value in gas day	short real		✓
24	33	p4MaxD	Maximum p4 value in gas day	short		✓

4				real		
25	60	tpeakMin	Minimum t value in registration period	short real	✓	
26	61	tpeakMax	Maximum t value in registration period	short real	✓	
27	62	tMinD	Minimum t value in gas day	short real		✓
28	63	tMaxD	Maximum t value in gas day	short real		✓
29	69	tamb	Ambient temperature	short real	✓	
30	70	tambMinD	Minimum ambient temperature value in gas day	short real		✓
31	71	tambMaxD	Maximum ambient temperature value in gas day	short real		✓
32	72	Uzas	System supply voltage	short real	✓	
33	73	UzasMinD	Minimum supply voltage in gas day	short real		✓
34	74	UzasMaxD	Maximum supply voltage in gas day	short real		✓
35	75	Urtc	RTC clock supply voltage	short real	✓	
36	76	UrtcMinD	RTC clock minimum supply voltage in gas day	short real		✓
37	77	UrtcMaxD	RTC clock maximum supply voltage in gas day	short real		✓
38	159	Vm	Gas volume counter in measuring conditions	uint64	✓	✓
39	225	E	Energy counter	uint64	✓	✓
40	226	Ee	Energy counter in emergency state	uint64	✓	✓
41	227	Es	Summary counter E+Ee	uint64	✓	✓
42	236	dVm	Increase in Vm in registration period	uint64	✓	
43	238	dVmD	Increase in Vm in gas day	uint64		✓
44	239	dVb	Increase Vb in registration period	uint64	✓	
45	242	dVbe	Increase Vbe in registration period	uint64	✓	
46	244	dVbeD	Increase Vbe in gas day	uint64		✓
47	245	dVbs	Increase Vbs in registration period		✓	
48	247	dVbsD	Increase Vbs in gas day	uint64		✓
49	248	dE	Increase in E in registration period	uint64	✓	
50	250	dED	Increase in E in gas day	uint64		✓
51	251	dEe	Increase in Ee in registration period	uint64	✓	
52	253	dEeD	Increase in Ee in gas day	uint64		✓
53	254	dEs	Increase in Es in registration period	uint64	✓	
54	256	dEsD	Increase in Es in gas day	uint64		✓
55	296	Vb_dbl	Volume counter in basic conditions	long real	✓	✓
56	297	Vbe_dbl	Volume counter in basic conditions In emergency state	long real	✓	✓
57	298	Vbs_dbl	Summary counter Vb+Vbe	long real	✓	✓
58	299	Vm_dbl	Gas volume counter in measuring conditions	long real	✓	✓
59	300	E_dbl	Energy counter	long real	✓	✓
60	301	Ee_dbl	Energy counter in emergency state	long real	✓	✓
6	302	Es_dbl	Summary counter E+Ee	long real	✓	✓

1						
6	303	dVm_dbl	Increase in Vm in registration period	long real	✓	
2						
6	305	dVmD_dbl	Increase in Vm in gas day	long real		✓
6	306	dVb_dbl	Increase in Vb in registration period	long real	✓	
4						
6	309	dVbe_dbl	Increase in Vbe in registration period	long real	✓	
6						
6	311	dVbeD_dbl	Increase in Vbe in gas day	long real		✓
6	312	dVbs_dbl	Increase in Vbs in registration period	long real	✓	
7						
6	314	dVbsD_dbl	Increase in Vbs in gas day	long real		✓
8						
6	315	dE_dbl	Increase in E in registration period	long real	✓	
9						
7	317	dED_dbl	Increase in E in gas day	long real		✓
7	318	dEe_dbl	Increase in Ee in registration period	long real	✓	
1						
7	320	dEeD_dbl	Increase in Ee in gas day	long real		✓
2						
7	321	dEs_dbl	Increase in Es in registration period	long real	✓	
3						
7	323	dEsD_dbl	Increase in Es in gas day	long real		✓
4						

14.1.2 Events

The following issues are registered as 'Events' in the CMK-03:

- change of the measured parameters over set limits
- occurrence of the outputs signals
- configuration change
- occurrence of the errors for calculating parameters
- firmware change.

The 'Events' are recorded in the internal rotary, non-volatile data base with capacity on the **1024** position.

The reading of the 'Alarms' and 'Events' is possible locally from the menu level (see part 11.1.2) or by means of **Gaz-Modem 1/2/3** protocols via one of three communication **COM (RS-GAZ2)** ports or one **OPTO-GAZ** port.

The "List of Events" is presented in the Table 14.2.

WARNING:

The occurrence of the '**Event**' or '**Alarms**' may cause the stop of volume counting to **Vb** counter and start the estimation to **Vbe** emergency counter.

Table 14.2. List of events In CMK-03 converter

Event code	Description	Counting into Vbe	Event code	Description	Counting into Vbe
0	CMK-03 start		33	5N signaling error	
1	p1 limit exceeded		34	6N signaling error	
2	p2 limit exceeded		35	p1 outside method's scope	
3	p3 limit exceeded		36	t outside method's scope	
4	p4 limit exceeded		37	p1 transducer malfunction (MID:3)	✓
5	t limit exceeded		38	t transducer malfunction (MID:4)	✓
6	p1 range exceeded (MID:0)	✓	39	K1 alarm replacement value (MID:5)	✓
7	p2 range exceeded		40	p1 replacement value enabled (MID:6)	✓
8	p3 range exceeded		41	t replacement value enabled (MID:7)	✓

9	p4 range exceeded		42	internal error (MID:8)	✓
10	Przekr. zakr. t (MID:1)	✓	43	Vb counter overflow (MID:128)	✓
11	to range exceeded		44	Configuration change (MID:129)	✓
12	CPC1 comm. Terror		45	Fill > 70% (MID:130)	✓
13	CPC2 comm. error		46	Database full (MID:131)	✓
14	CPC3 comm. Terror		47	Alarms confirmed (MID:132)	✓
15	CPC4 comm. Terror		48	Battery < 10% (MID:133)	✓
16	Signaling no. 1		49	Alg. Z range exceeded (MID:2)	✓
17	Signaling no. 2		50	Calculation method error	
18	Signaling no. 3		51	Open LFb ctrl. contact	
19	Signaling no. 4		52	Qm limit exceeded	
20	Signaling no. 5		53	Qb limit exceeded	
21	Signaling no. 6		54	Qm meter range exceeded	
22	Configuration lock		55	OPTO-GAZ active	
23	External pwr. Supp		56	dVbsh1 limit exceeded	
24	NAMUR pwr. supp.		57	dVbsh2 limit exceeded	
25	Battery 1 disconnected		58	dVbsh3 limit exceeded	
26	Battery 2 disconnected		59	eph1 limit exceeded	
27	Check CALC		60	eph2 limit exceeded	
28	Time change		61	Vm change	
29	Aut. time change		62	Qmin < Qm < QmStop	
30	Value modification		63	eHF limit exceeded	
31	String modification				
32	Firmware upgraded (MID:134)	✓			

14.2 Reading and configuration in telemetric systems

The **CMK-03** volume converter is equipped in three independent communication **RS485** ports. They are executed as intrinsically safe ports in the **RS-GAZ2** standard. The configuration and remote reading in the telemetric systems is realized by using the **Gaz-Modem 1/2/3** protocol.

The connection of communication ports (**COM1**, **COM2**, **COM3**), to the remote telemetric system is provided by using a intrinsically safe power supply–converter e.g. **CZAK-03** (see **Table 2.1** Additional Accessories). There is also possible to use other power supply device with conformed parameters according to the **Table 4.13**.

Example of the telemetric systems is presented in **Figure 14.1**.

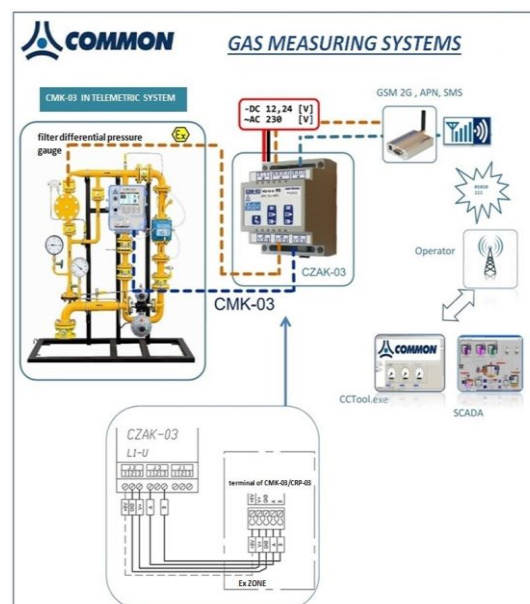

Figure 14.1 Example of telemetric system

The connection diagram of the **CZAK-03** clamps to the **CMK-03** clamps is presented in **Figure 14.2**.

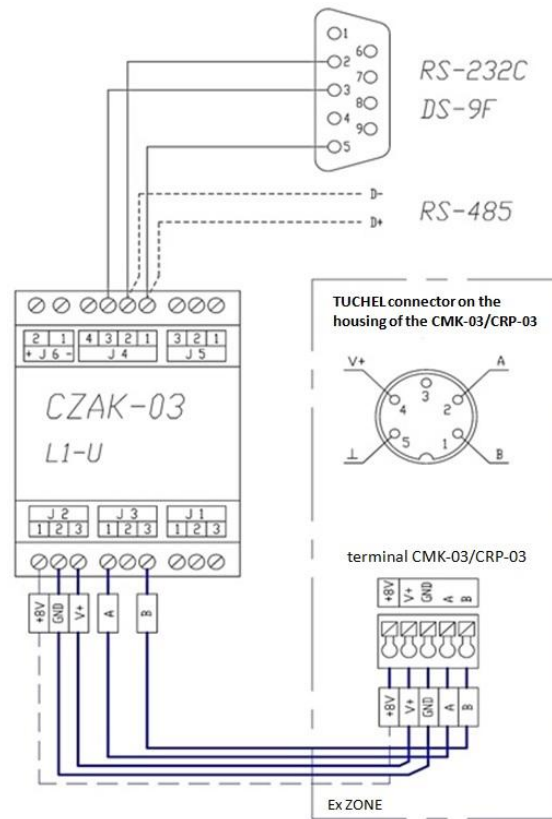

Figure 14.2 Connection method of the CZAK-03 clamps into CMK-03 clamps

To provide the power supply to the volume converter and receive one transmission channel outside the Ex zone, it is necessary to connect the cables of CZAK-03 clamps which are marked with labels **V+**, **GND**, **A**, **B** to the identically marked clamps of the selected transmission port: **COM1 (TUCHEL)**, **COM2** or **COM3**.

If the **CMK-03** will operate with **NAMUR** type reed transmitters, (the **HF transmitter** of gas meter or the **proximity detectors**) which are connected to the **IN5** and/or **IN6** input, it is necessary to connect the additionally cable form CZAK-03 unit (except the external power supply **V+**, **GND**), which will provide the voltage **+8,2V** to **NAMUR** circuits marked with **+8V** label.

15 Environmental protection.

15.1 Packaging waste

Packaging of delivered device should not be disposed as a municipal waste.



Packaging has been marked with a recycling symbol. According to the Packaging Regulations, the user is obliged to ensure that individual elements of packaging are thrown into right containers for separate collection.

15.2 Disposal of used batteries and devices after life-time.

There is not allowed to throw out as a municipal waste the items listed below:

- used batteries
- used accumulators after replacing
- used devices after ending of their life-time

The items are marked with the symbol:



The batteries (accumulators) and other parts of the devices contain hazardous and harmful substances. The substances subject under the regulation of Waste Collection and should be prevent against the penetration to natural environment.

If the company has not settled the procedure regarding to the electronically waste, the used batteries and/or devices should be always delivered to proper collection point. The information about free of charge collection points should be available on the website of municipal office.

16 History of changes in documentation

version	data	change description
101U	May 2015	first edition
102U	June 2016	second extended edition filled with technical descriptions and functionalities

17 Notes

A large, empty rectangular box with a thin black border, occupying most of the page below the section header. It is intended for the user to write notes.